

G3-MSJ-UK 2:1

Call 800-321-7800 or visit us online at www.nookindustries.com to configure and order your G3-MSJ-UK 2:1 today!

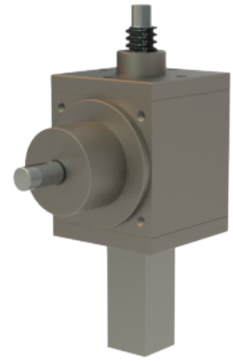
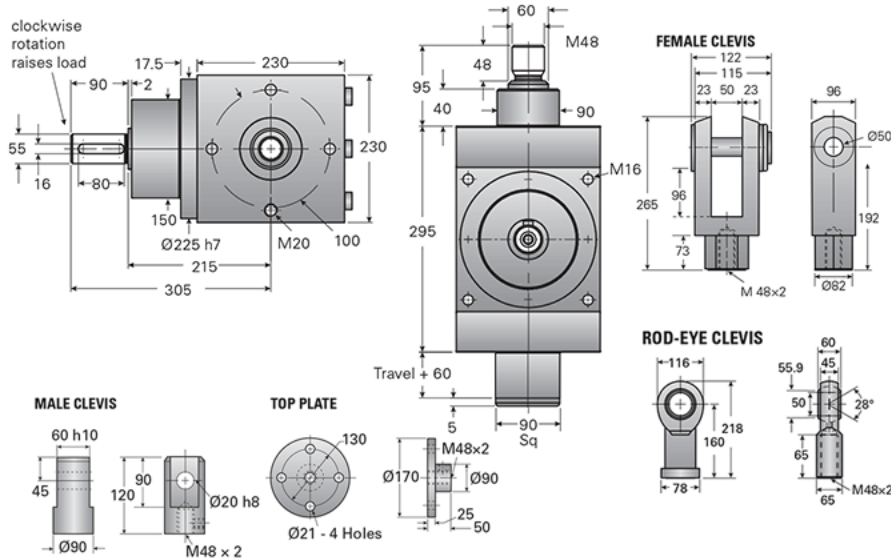

Details

Capacity [kN]	117
Gear Ratio	2:1
Raise for One Turn of Worm [mm]	4.50
Torque to Raise 1 kN [Nm]	2.05
Tare Drag Torque [Nm]	4.40
Lifting Screw Diameter [mm]	60
Screw Lead [mm]	9
BackDrive Holding Torque [Nm]	13.65

Performance Specifications

Maximum Input Torque [Nm]	1600
---------------------------	------

Weight

Base 0 Travel [kg]	36.30
Per 100mm of Travel [kg]	2.12
Grease [kg]	1.00