

MBN16x10R-3CW

Call 800-321-7800 or visit us online at www.nookindustries.com to configure and order your MBN16x10R-3CW today!

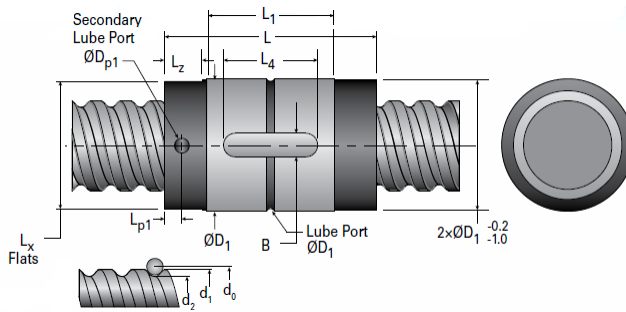

Product Info

Nominal Rod Diameter [mm]	16
Material	Alloy
Thread Direction	RH

Details

Lead [mm]	10
Active Turns	3
Nominal Ball Dia. [mm]	3.000
Screw Weight [kg/m]	1.24
Nut Weight [kg]	0.12
End Code for Types 1,2, and 3	12
End Code for Types 4	8
End Code for Types 5	12
End Code for Types 6	12
End Code for Types 7	10

Performance Specifications

Dynamic Load Ca [N]	8590
Static Load [N]	14290
Linear Speed (Based on DN Values) [mm/min]	43800

Screw Dimensions

d0 [mm]	16
d1 [mm]	14.98
d2 [mm]	12.90

Nut Dimensions

D1 (g6) [mm]	28
L1 [mm]	45
Dp [mm]	1.5
Lp1 [mm]	9.5
Dp1 [mm]	4
L [mm]	45
Lx [mm]	27
Lz [mm]	8
L4 [mm]	20
B (P9) [mm]	5