

252-24-LXX/1500-0500 SRT RA

Call 800-321-7800 or visit us online at www.nookindustries.com to configure and order your 252-24-LXX/1500-0500 SRT RA today!

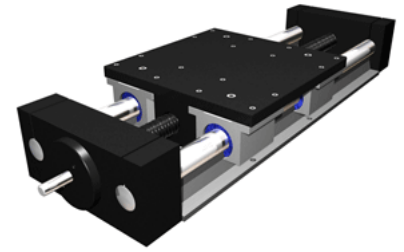
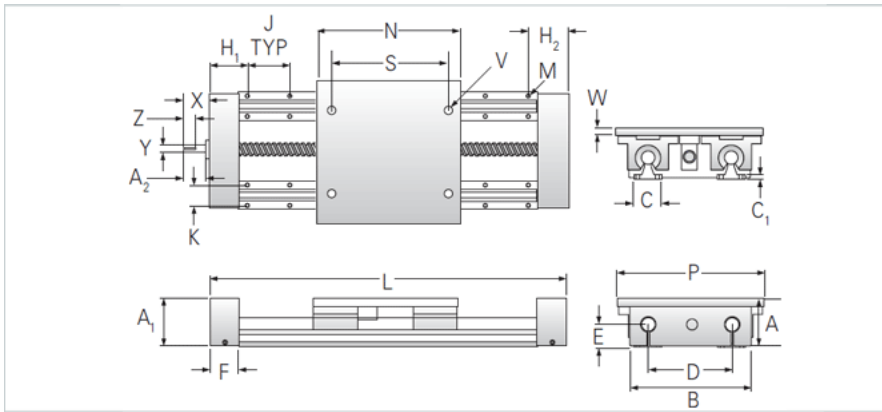

Product Info

Nominal Shaft Diameter [in]	1.50
Screw Type	Ball
Screw Size	1500-0500 SRT

Dimensions

A +/-0.003 [in]	5.000
A1 [in]	4.88
B [in]	10.75
C [in]	3.00
C1 [in]	0.38
D [in]	8.00
E [in]	2.50
F [in]	2.8
H [in]	4.00
J +/-0.010 [in]	8.000
K +/-0.010 [in]	2.250
M - Bolt	3/8
M - Hole [in]	0.41
N [in]	13.00
P [in]	13.00
S [in]	10.00
U [in]	8.00
V	1/2-13
W [in]	0.75
Minimum L Dimension TRAVEL + [in]	18.6
X [in]	2.32
Y [in]	0.750
Z	1.14 x .188
A2 [in]	1.657

Performance specifications

Load Maximum System [lbf]	6200
---------------------------	------