

## 252-08-LXX/055 RA

Call 800-321-7800 or visit us online at [www.nookindustries.com](http://www.nookindustries.com) to configure and order your 252-08-LXX/055 RA today!

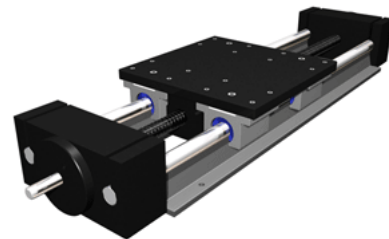
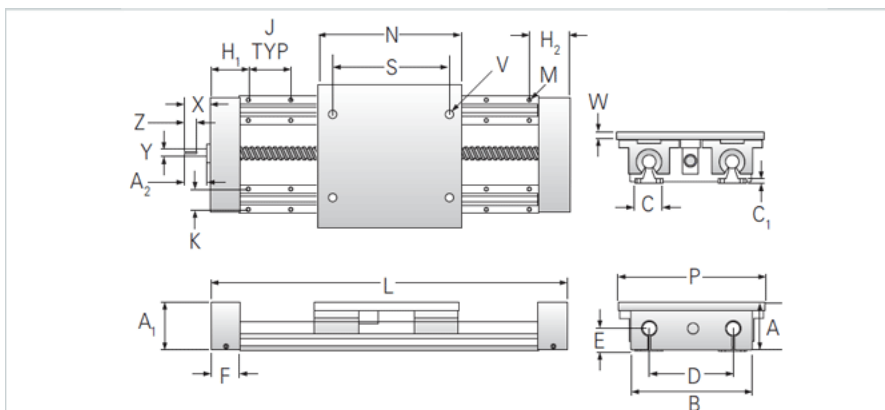

### Product Info

Nominal Shaft Diameter [in]	0.50
Screw Type	Acme
Screw Size	1/2-5

### Dimensions

A +/-0.003 [in]	2.187
A1 [in]	2.13
B [in]	4.25
C [in]	1.50
C1 [in]	0.19
D [in]	3.25
E [in]	1.13
F [in]	1.5
H [in]	2.00
J +/-0.010 [in]	4.000
K +/-0.010 [in]	1.000
M - Bolt	#6
M - Hole [in]	0.17
N [in]	5.50
P [in]	5.50
S [in]	4.50
U [in]	3.25
V	1/4-20
W [in]	0.38
Minimum L Dimension TRAVEL + [in]	8.5
X [in]	1.00
Y [in]	0.250
Z	.51 x .095
A2 [in]	0.665

### Performance specifications

Load Maximum System [lbf]	760
---------------------------	-----