

212-16-LXX/1000-0500 SRT RA

Call 800-321-7800 or visit us online at www.nookindustries.com to configure and order your 212-16-LXX/1000-0500 SRT RA today!

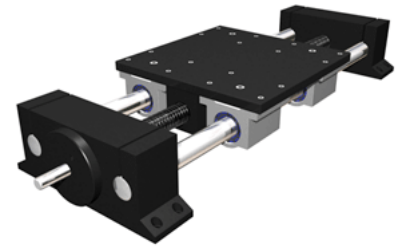
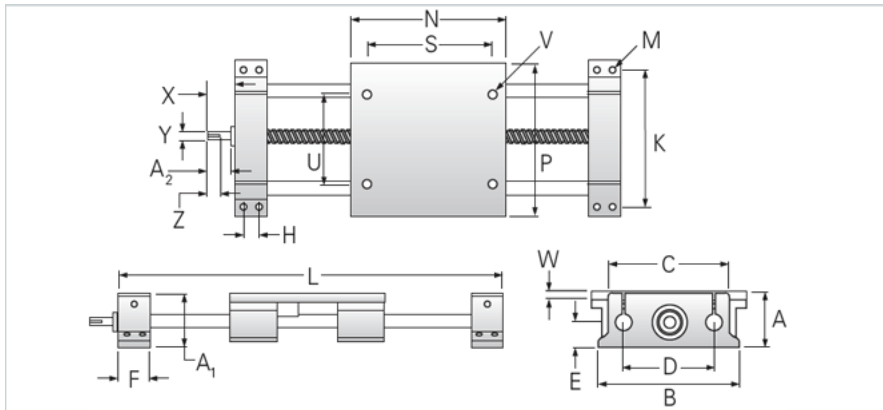

Product Info

Nominal Shaft Diameter [in]	1.00
Screw Type	Ball
Screw Size	1000-0500 SRT

Dimensions

A +/-0.003 [in]	3.437
A1 [in]	3.45
B [in]	8.75
C [in]	7.25
D [in]	5.50
E [in]	1.75
F [in]	2.20
H +/-0.010 [in]	1.200
K +/-0.010 [in]	8.000
M - Bolt	1/4
M - Hole [in]	0.28
N [in]	9.00
P [in]	9.00
S [in]	7.00
U [in]	5.50
V	3/8-16
W [in]	0.50
Minimum L Dimension TRAVEL + [in]	13.4
X [in]	1.74
Y [in]	0.625
Z	1.03 x .188
A2 [in]	1.260

Performance specifications

Load Maximum System [lbf]	2900
---------------------------	------