

## NIA5-115-10-B

Call 800-321-7800 or visit us online at [www.nookindustries.com](http://www.nookindustries.com) to configure and order your NIA5-115-10-B today!

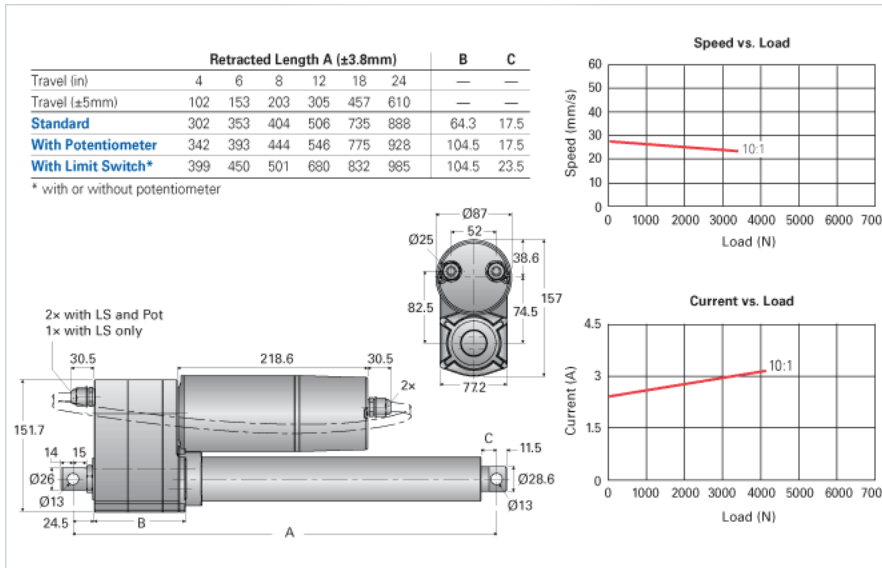

### Product Info

Screw Type

Ball Screw

### Details

Voltage [VAC]

115

Hertz [Hz]

60

Gear Ratio

10:1

Speed At No Load [mm/s]

21.8

Speed At Full Load [mm/s]

17.5

Load Capacity Dynamic Load [N]

3500

Load Capacity Static Load [N]

13600

Amps

3.1

### Performance Specifications

Duty Cycle [% of 5 Minutes]

25

Rated Cycles At Full Load

10000

Protection Class

IP65