

ND8-12-20-B

Call 800-321-7800 or visit us online at www.nookindustries.com to configure and order your ND8-12-20-B today!



Travel (in)	Retracted Length A ($\pm 3.8\text{mm}$)							B	C
	4	6	8	10	12	18	24		
Travel ($\pm 5\text{mm}$)	102	153	203	254	305	457	610	—	—
Standard	302	353	404	455	506	735	888	64.3	17.5
With Potentiometer	342	393	444	495	546	775	928	104.5	17.5
With Limit Switch*	399	450	501	552	680	832	985	104.5	23.5

* with or without potentiometer

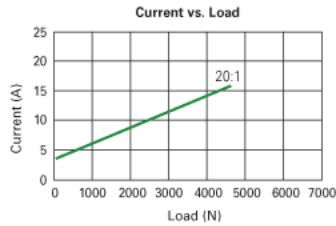
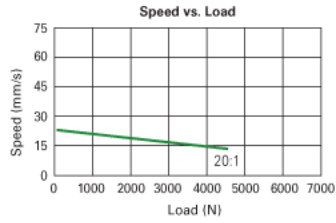
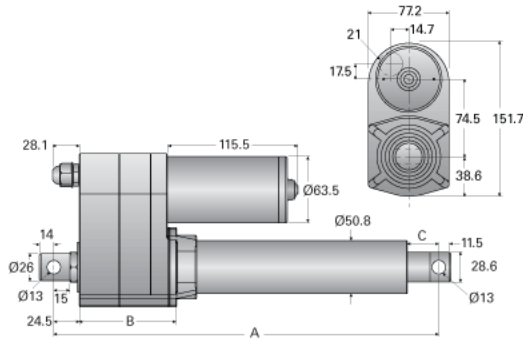

Product Info

Screw Type

Ball Screw

Details

Voltage [VDC]

12

Gear Ratio

20:1

Speed At No Load [mm/s]

17

Speed At Full Load [mm/s]

14.3

Load Capacity Dynamic Load [N]

4500

Load Capacity Static Load [N]

13600

Amps

16

Performance Specifications

Duty Cycle [% of 5 Minutes]

25

Rated Cycles At Full Load

10000

Protection Class

IP65