

RAD-3022-A4

Call 800-321-7800 or visit us online at www.nookindustries.com to configure and order your RAD-3022-A4 today!

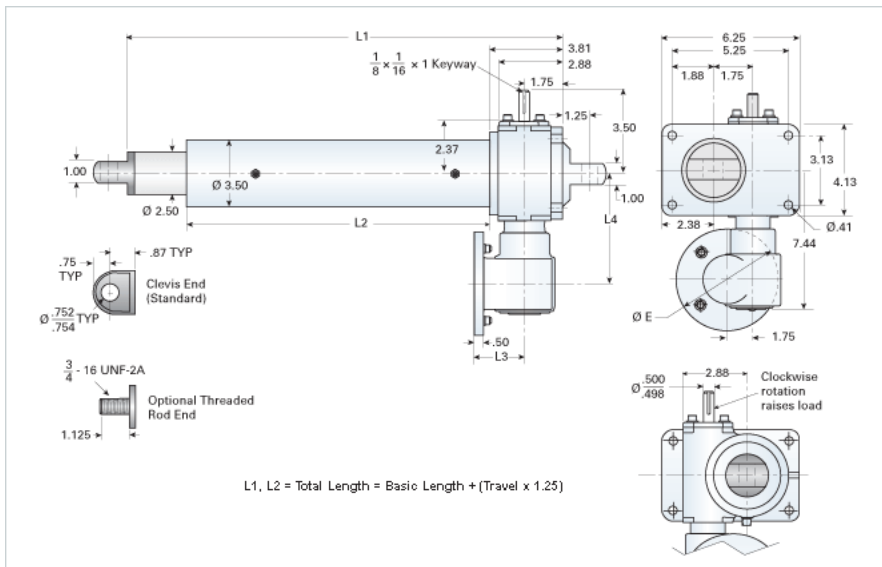

Details

Gear Ratio Primary Reduction	12:1
Gear Ratio Secondary Reduction	12:1
Max Capacity [lb]	6000
Input Turns per Inch of Travel	576
Torque to Raise 1 lb. [in-lb]	0.0025
Acme Screw	1 1/4-4 RA
Screw Lead [in]	0.250
Root Diameter [in]	0.947
Max HP [hp]	0.5

Weight

Basic Weight [lb]	47
Per Inch of Travel [lb]	1.35

Tube Dimensions

L1 Basic Length [in]	10.50
L2 Basic Length [in]	5.13

NEMA 56C Dimensions

L3 [in]	3.69
L4 [in]	5.63
E [in]	6.69

NEMA 180TC Dimensions

L3 [in]	-
L4 [in]	-
F [in]	-