

RAD-20088-HL

Call 800-321-7800 or visit us online at www.nookindustries.com to configure and order your RAD-20088-HL today!

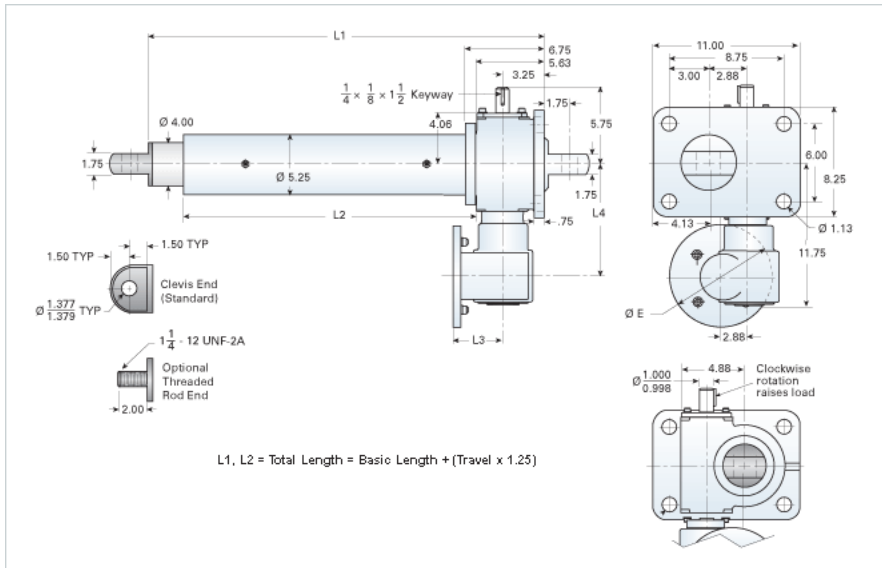

Details

Gear Ratio Primary Reduction	8:1
Gear Ratio Secondary Reduction	8:1
Max Capacity [lb]	40000
Input Turns Per Inch Of Travel	64
Torque To Raise 1 lb. [in-lb]	0.0062
Ball Screw	2250-1000 SRT RA
Screw Lead [in]	1.000
Root Diameter [in]	1.850
Max HP [hp]	5

Weight

Basic Weight [lb]	202
Per Inch of Travel [lb]	3.31

Tube Dimensions

L1 Basic Length [in]	21.13
L2 Basic Length [in]	12.63

NEMA 56C Dimensions

L3 [in]	6.12
L4 [in]	9.00
E [in]	9.12

NEMA 180TC Dimensions

L3 [in]	-
L4 [in]	-
F [in]	-