

## DD-20024-HD

Call 800-321-7800 or visit us online at [www.nookindustries.com](http://www.nookindustries.com) to configure and order your DD-20024-HD today!

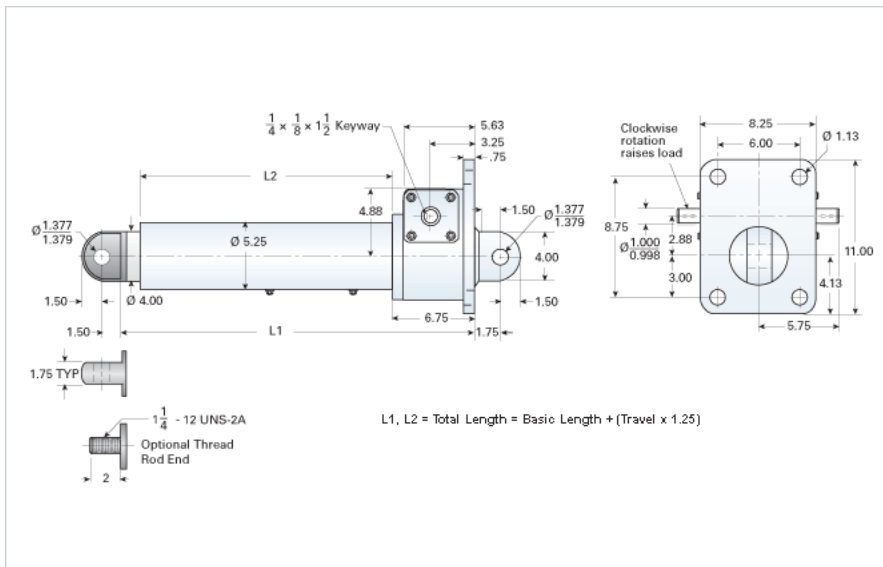

### Details

Gear Ratio	24:1
Max Capacity [lb]	40000
Input Turns Per Inch Of Travel	48
Torque To Raise 1 lb. [in-lb]	0.0079
Ball Screw	2250-0500 SRT RA
Screw Lead [in]	0.500
Root Diameter [in]	1.850
Max HP [hp]	2.5

### Weight

Basic Weight [lb]	154
Per Inch of Travel [lb]	3.31

### Tube Dimensions

L1 Basic Length [in]	21.13
L2 Basic Length [in]	12.63

### NEMA 42 Dimensions

L3 [in]	-
E [in]	-
F [in]	-

### NEMA 48 Dimensions

L3 [in]	-
E [in]	-
F [in]	-

### NEMA 56C Dimensions

L3 [in]	8.65
E [in]	6.75
F [in]	5.19

### NEMA 182TC Dimensions

L3 [in]	-
E [in]	-

### NEMA 182TC/18TCc Dimensions

F [in]	-
--------	---

### NEMA 184TC Dimensions

L3 [in]	9.00
E [in]	9.25
F [in]	5.19

### NEMA 213TC Dimensions

L3 [in]	9.65
E [in]	9.25
F [in]	5.69