

DD-3024-HD

Call 800-321-7800 or visit us online at www.nookindustries.com to configure and order your DD-3024-HD today!

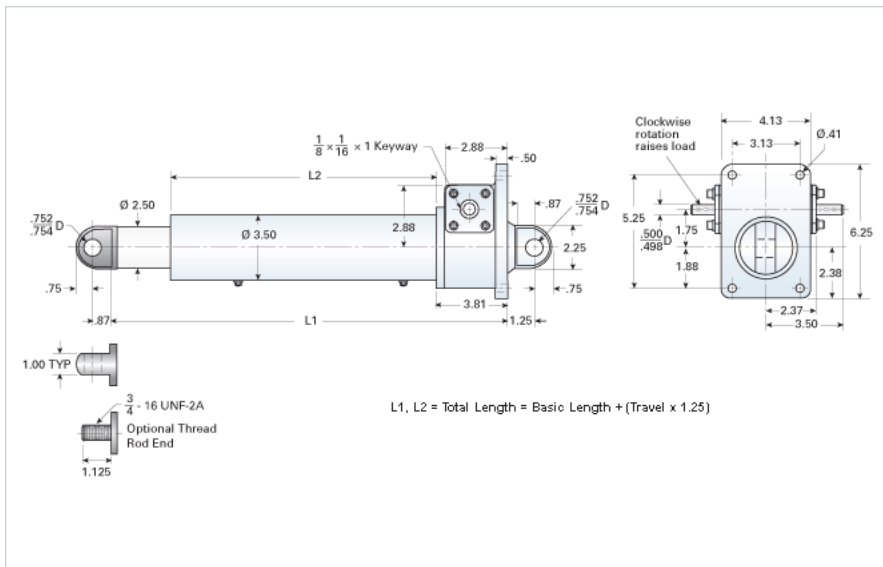

Details

Gear Ratio	24:1
Max Capacity [lb]	6000
Input Turns Per Inch Of Travel	58.1
Torque To Raise 1 lb. [in-lb]	0.007
Ball Screw	1171-0413 SRT RA
Screw Lead [in]	0.413
Root Diameter [in]	0.870
Max HP [hp]	0.5

Weight

Basic Weight [lb]	38
Per Inch of Travel [lb]	1.31

Tube Dimensions

L1 Basic Length [in]	12.44
L2 Basic Length [in]	7.13

NEMA 42 Dimensions

L3 [in]	-
E [in]	-
F [in]	-

NEMA 48 Dimensions

L3 [in]	-
E [in]	-
F [in]	-

NEMA 56C Dimensions

L3 [in]	6.25
E [in]	6.62
F [in]	3.50

NEMA 182TC Dimensions

L3 [in]	-
E [in]	-

NEMA 182TC/18TCc Dimensions

F [in]	-
--------	---

NEMA 184TC Dimensions

L3 [in]	-
E [in]	-
F [in]	-

NEMA 213TC Dimensions

L3 [in]	-
E [in]	-
F [in]	-