

DLSZ 160 Extended Carriage 8 Split Rollers

Call 800-321-7800 or visit us online at www.nookindustries.com to configure and order your DLSZ 160 Extended Carriage 8 Split Rollers today!

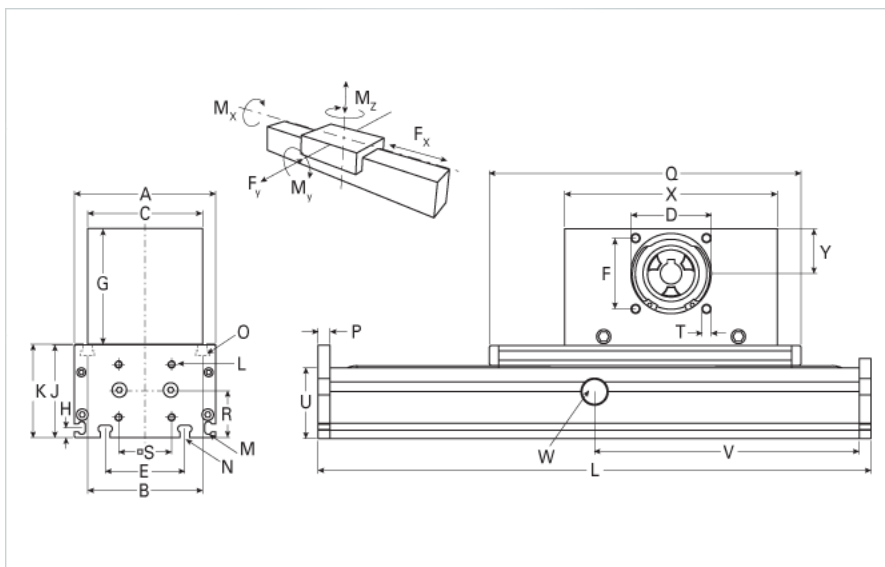
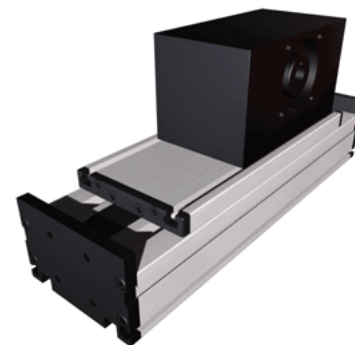

Details

Size	160
Belt	8M50
mm/Rev	256
Number of Teeth	32
Pully Diameter [mm]	81.5

Dimensions

Basic Length L [mm]	530
A [mm]	160
B [mm]	130
C [mm]	90
D [mm]	90
E [mm]	90
F [mm]	80
G [mm]	130
H [mm]	11
J [mm]	105
K [mm]	106
M	M6
N	M8
O	M8
P [mm]	12
Q [mm]	490
R [mm]	53
S [mm]	60
T	M10
U [mm]	80
X [mm]	270
Y [mm]	60
Shaft Diameter and Length [mm]	22 x 45
Key	6x6x40

Speed

Speed Maximum [m/s]	6
---------------------	---

Forces and Torques

No-load torque [Nm]	1.5
Tensile force 0.2 sec [N]	4300
Tensile force permanent [N]	4000
Fx dynamic [N]	3800
Fy dynamic [N]	2000
Fz dynamic [N]	2800
Mx dynamic [Nm]	400
My dynamic [Nm]	300
Mz dynamic [Nm]	150
Fx static [N]	4000
Fy static [N]	3000
Fz static [N]	3500
Mx static [Nm]	125
My static [Nm]	360

Mz static [Nm]	180
Geometrical moments of inertia of aluminum profile	
Elastic modulus [N/mm ²]	70000
Ix [mm ⁴]	2220000
Iy [mm ⁴]	12200000
Weight	
Additional Weight per 100 mm [kg] [.00}	1.8
Basic Weight [kg]	27.0