

QLR 100 Extended Carriage 4 Split Rollers

Call 800-321-7800 or visit us online at www.nookindustries.com to configure and order your QLR 100 Extended Carriage 4 Split Rollers today!

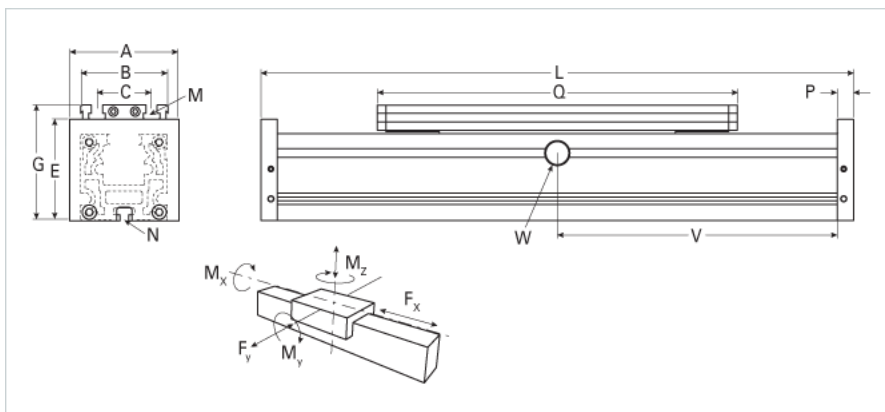

Details	
Size	100
Dimensions	
Basic Length L [mm]	430
A [mm]	130
B [mm]	100
C [mm]	66
E [mm]	110
G [mm]	129
M	M10
N	M10
P [mm]	20
Q [mm]	388
Speed	
Speed Maximum [m/s]	7
Forces and Torques	
F _x dynamic [N]	-
F _y dynamic [N]	1500
F _z dynamic [N]	1700
M _x dynamic [Nm]	60
M _y dynamic [Nm]	110
M _z dynamic [Nm]	90
F _x static [N]	-
F _y static [N]	1900
F _z static [N]	2100
M _x static [Nm]	85
M _y static [Nm]	140
M _z static [Nm]	110
Geometrical moments of inertia of aluminum profile	
Elastic modulus [N/mm ²]	70000
I _x [mm ⁴]	4300000
I _y [mm ⁴]	4880000
Weight	
Additional Weight per 100 mm [kg]	1.42
Basic Weight [kg]	7.2