

QLR 100 Extended Carriage

Call 800-321-7800 or visit us online at www.nookindustries.com to configure and order your QLR 100 Extended Carriage today!

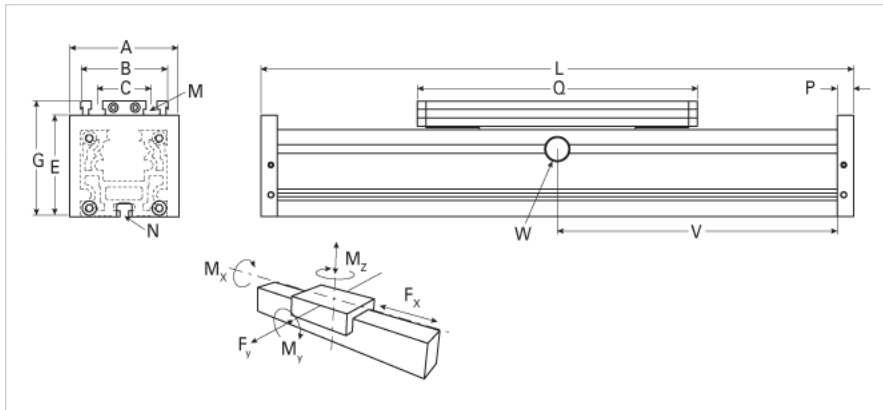

Details

Size 100

Dimensions

Basic Length L [mm]	370
A [mm]	130
B [mm]	100
C [mm]	66
E [mm]	110
G [mm]	129
M	M10
N	M10
P [mm]	20
Q [mm]	320

Speed

Speed Maximum [m/s] 7

Forces and Torques

Fx dynamic [N]	-
Fy dynamic [N]	1500
Fz dynamic [N]	1700
Mx dynamic [Nm]	60
My dynamic [Nm]	110
Mz dynamic [Nm]	90
Fx static [N]	-
Fy static [N]	1900
Fz static [N]	2100
Mx static [Nm]	85
My static [Nm]	140
Mz static [Nm]	110

Geometrical moments of inertia of aluminum profile

Elastic modulus [N/mm ²]	70000
Ix [mm ⁴]	4300000
Iy [mm ⁴]	4880000

Weight

Additional Weight per 100 mm [kg]	1.42
Basic Weight [kg]	7.2