

## ELR 40 WAC

Call 800-321-7800 or visit us online at [www.nookindustries.com](http://www.nookindustries.com) to configure and order your ELR 40 WAC today!

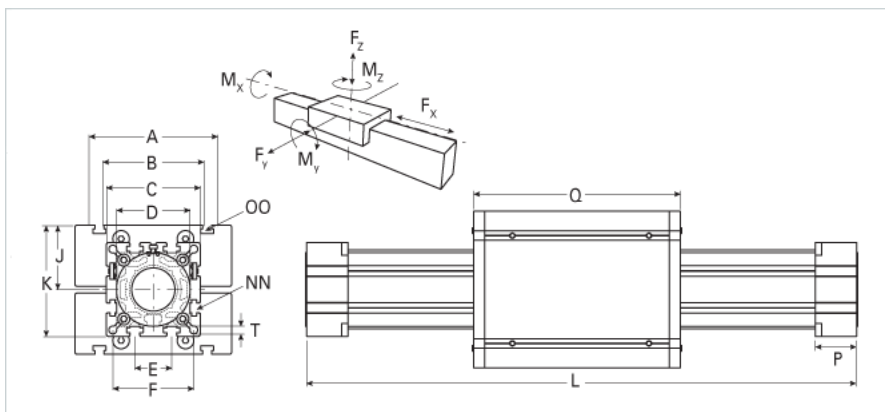

Details	
Size	40
Dimensions	
Basic Length L [mm]	191
A [mm]	100
B [mm]	66
C [mm]	58
D [mm]	48x1
E [mm]	18
F [mm]	47
G [mm]	-
H [mm]	-
K [mm]	64
MM	-
NN	M6
OO	M6
P [mm]	25
Q [mm]	138
T-Diameter [mm]	6.5
Forces and Torques	
Fx dynamic [N]	-
Fy dynamic [N]	700
Fz dynamic [N]	650
Mx dynamic [Nm]	20
My dynamic [Nm]	18
Mz dynamic [Nm]	25
Fx static [N]	-
Fy static [N]	1200
Fz static [N]	900
Mx static [Nm]	25
My static [Nm]	32
Mz static [Nm]	35
No-load torque Maximum [m/s]	4
Geometrical moments of inertia of aluminum profile	
Elastic modulus [N/mm <sup>2</sup> ]	70000
Ix [mm <sup>4</sup> ]	132000
Iy [mm <sup>4</sup> ]	134000
Weight	
Additional Weight per 100 mm [kg]	0.23
Basic Weight [kg]	0.9