

## NH55TB Assembly

Call 800-321-7800 or visit us online at [www.nookindustries.com](http://www.nookindustries.com) to configure and order your NH55TB Assembly today!

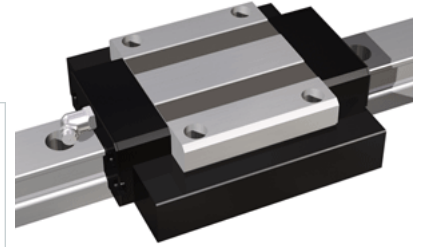
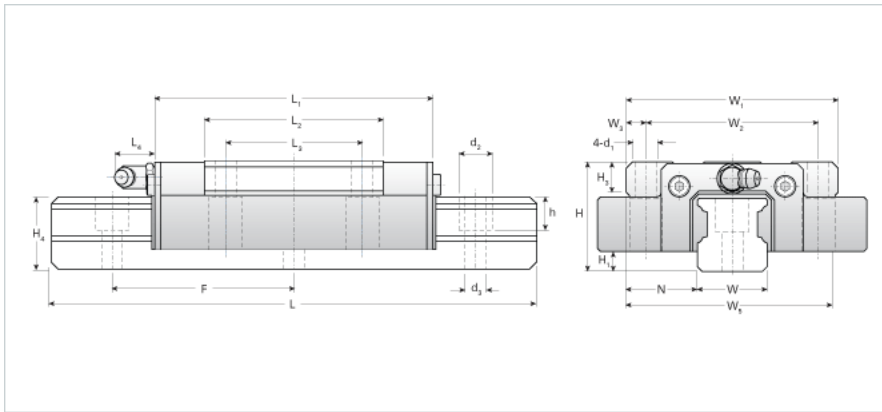

<b>Dimensions</b>	
H [mm]	70
H1 [mm]	14
N [mm]	43.5
<b>Metric Profile Rail (Rail)Details</b>	
Size [mm]	55
Type	Standard
<b>(Rail)Dimensions</b>	
d2 [mm]	23
d3 [mm]	16
h [mm]	24
H4 [mm]	48
F [mm]	120
W [mm]	53
Maximum Length [mm]	3000
<b>(Rail)Weight</b>	
Weights-Rail [kg/m]	16.5
<b>Metric Runner Block, Heavy Load, High Speed, 4 Through Holes On Flange (Runner Block)Details</b>	
Size [mm]	55
<b>(Runner Block)Dimensions</b>	
L1 [mm]	189
L2 [mm]	124
L3 [mm]	95
L4 [mm]	12
d1 x l	M14x23
H3 [mm]	17
W1 [mm]	140
W2 [mm]	116
W3 [mm]	12
W5 [mm]	171
<b>(Runner Block)Forces and Torques</b>	
Basic Load Ratings C [kN]	90.02
Basic Load Ratings C [lbf]	20232
Basic Load Ratings C0 [kN]	137.09
Basic Load Ratings C0 [lbf]	30811
Static Moment Ratings-Ma [kN-m]	2.22
Static Moment Ratings-Ma [lb-in]	19617
Static Moment Ratings-Mb [kN-m]	2.22
Static Moment Ratings-Mb [lb-in]	19617
Static Moment Ratings-Mc [kN-m]	4.25
Static Moment Ratings-Mc [lb-in]	37671
<b>(Runner Block)Weight</b>	
Weight-Block [kg]	4.40
<b>(Runner Block)Grease Fitting</b>	
Grease Fitting Part Number	B-PT-1/8