

NH30TR Assembly

Call 800-321-7800 or visit us online at www.nookindustries.com to configure and order your NH30TR Assembly today!

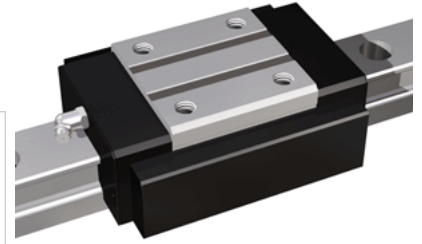
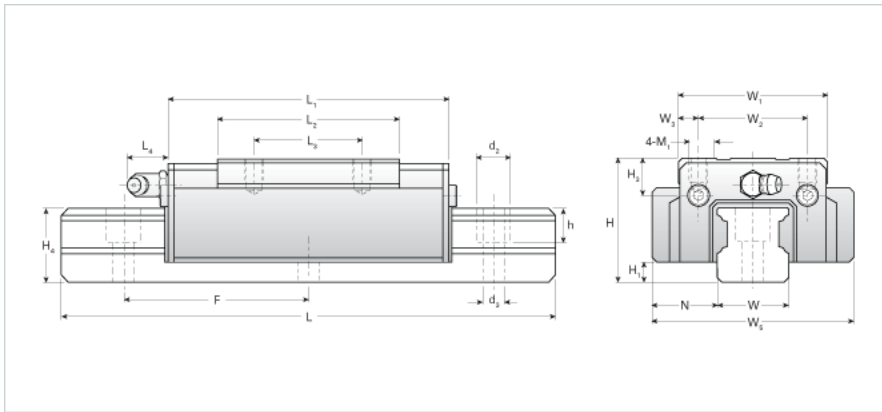

Dimensions	
H [mm]	45
H1 [mm]	7
N [mm]	16.0
Metric Profile Rail (Rail)Details	
Size [mm]	30
Type	Standard
(Rail)Dimensions	
d2 [mm]	14
d3 [mm]	9
h [mm]	14
H4 [mm]	28
F [mm]	80
W [mm]	28
Maximum Length [mm]	4000
(Rail)Weight	
Weights-Rail [kg/m]	5.3
Metric Runner Block, Heavy Load, High Speed, 4 Tapped Holes On Runner Block (Runner Block)Details	
Size [mm]	30
(Runner Block)Dimensions	
H3 [mm]	8
L1 [mm]	102
L2 [mm]	59
L3 [mm]	40
L4 [mm]	10
M1 x l	M8X10
W1 [mm]	60
W2 [mm]	40
W3 [mm]	10
W5 [mm]	81
(Runner Block)Forces and Torques	
Basic Load Ratings C [kN]	25.00
Basic Load Ratings C [lbf]	5620
Basic Load Ratings C0 [kN]	39.71
Basic Load Ratings C0 [lbf]	8926
Static Moment Ratings-Ma [kN-m]	0.31
Static Moment Ratings-Ma [lb-in]	2778
Static Moment Ratings-Mb [kN-m]	0.31
Static Moment Ratings-Mb [lb-in]	2778
Static Moment Ratings-Mc [kN-m]	0.62
Static Moment Ratings-Mc [lb-in]	5468
(Runner Block)Weight	
Weight-Block [kg]	0.75
(Runner Block)Grease Fitting	
Grease Fitting Part Number	B-M6F