

## Type 5N, End Code 40

Call 800-321-7800 or visit us online at [www.nookindustries.com](http://www.nookindustries.com) to configure and order your Type 5N, End Code 40 today!

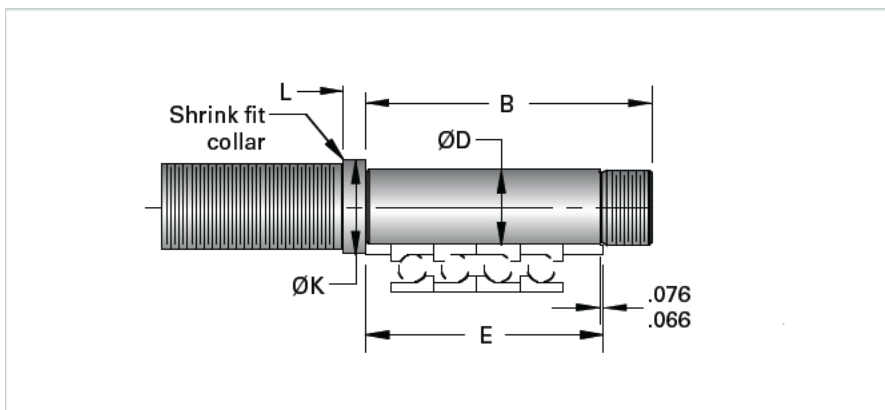

### Product Info

Nominal Bearing Journal Size [mm]

40

### Dimensions

B [mm]

153

D Maximum [mm]

40.011

D Minimum [mm]

44.995

E [mm]

127

K [mm]

50

L [mm]

12

Lock Nut

SFZ 40X1.5