

Type 5N, End Code 25

Call 800-321-7800 or visit us online at www.nookindustries.com to configure and order your Type 5N, End Code 25 today!

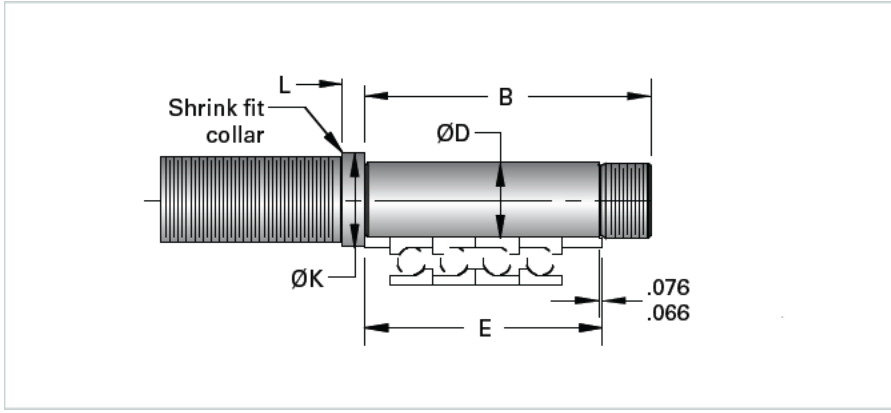

Product Info

Nominal Bearing Journal Size [mm] 25

Dimensions

B [mm]	119
D Maximum [mm]	25.009
D Minimum [mm]	24.996
E [mm]	95
K [mm]	32
L [mm]	10
Lock Nut	SFZ 25X1.5