

Type 5L, End Code 45

Call 800-321-7800 or visit us online at www.nookindustries.com to configure and order your Type 5L, End Code 45 today!

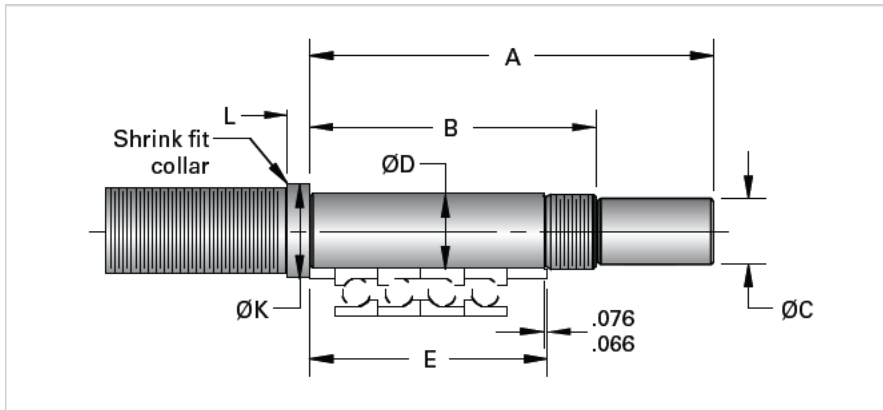

Product Info

Nominal Bearing Journal Size [mm] 45

Dimensions

A [mm]	228
B [mm]	163
C Maximum [mm]	40.00
C Minimum [mm]	39.97
D Maximum [mm]	45.011
D Minimum [mm]	44.995
E [mm]	137
K [mm]	55
L [mm]	12
Lock Nut	SFZ 45X1.5