

Type 5L, End Code 20

Call 800-321-7800 or visit us online at www.nookindustries.com to configure and order your Type 5L, End Code 20 today!

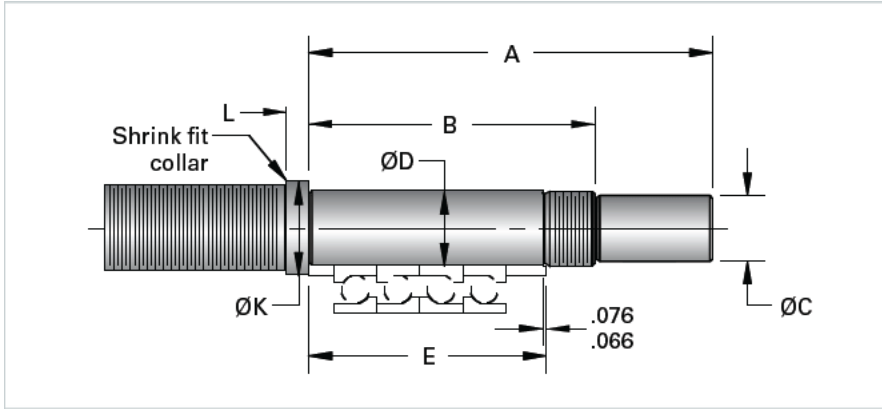

Product Info

Nominal Bearing Journal Size [mm] 20

Dimensions

A [mm]	151
B [mm]	105
C Maximum [mm]	17.00
C Minimum [mm]	16.97
D Maximum [mm]	20.009
D Minimum [mm]	19.996
E [mm]	84
K [mm]	28
L [mm]	9
Lock Nut	SFZ 20X1