

Type 5K, End Code 60

Call 800-321-7800 or visit us online at www.nookindustries.com to configure and order your Type 5K, End Code 60 today!

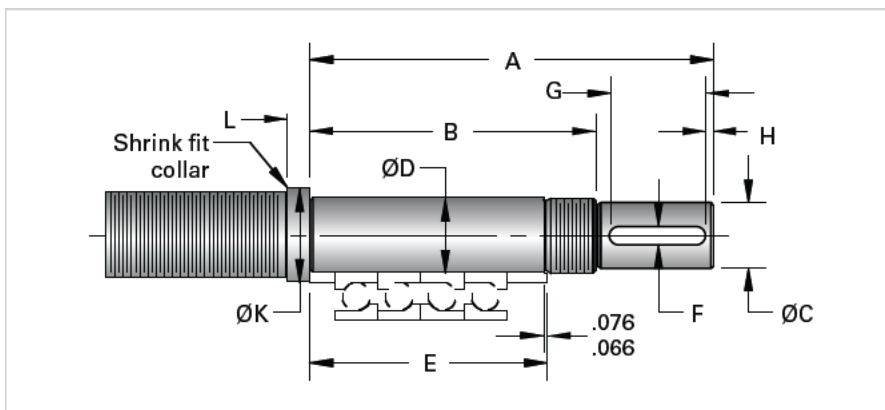

Product Info

Nominal Bearing Journal Size [mm] 60

Dimensions

A [mm]	291
B [mm]	202
C Maximum [mm]	55
C Minimum [mm]	54.97
D Maximum [mm]	60.012
D Minimum [mm]	59.993
E [mm]	171
F [mm]	16
G [mm]	71
H [mm]	6
K [mm]	75
L [mm]	16
Lock Nut	SFZ 60X2