

EZZE-MOUNT EZM-3012-23

Call 800-321-7800 or visit us online at www.nookindustries.com to configure and order your EZZE-MOUNT EZM-3012-23 today!

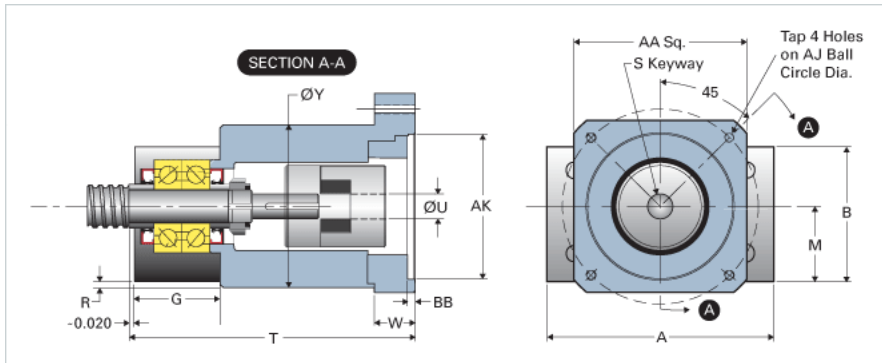
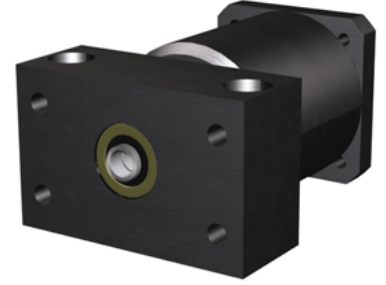

Product Info

Part Number	EZM-3012-23
Reference Code	U2
Machined End Code	12
Nema Frame Reference	23
Nominal Bearing Journal Size [mm]	12

Dimensions

A [in]	3.50
AA [in]	2.50
AJ [in]	2.625
AK Maximum [in]	1.506
AK Minimum [in]	1.503
B [in]	2.22
BB [in]	0.19
[in]	2.75
D [in]	3.29
E [in]	1.25
F [in]	0.50
G [in]	1.38
H [in]	0.69
J [in]	1.30
K Shaft Diameter Maximum [in]	0.406
K Shaft Diameter Minimum [in]	0.405
L Holes [Number of Holes]	4
L Thru [in]	0.028
M [in]	1.187
N	-
Q [in]	0.33
R [in]	0.10
S [in]	0.125
T [in]	4.48
U [in]	0.38
W [in]	0.38
Y [in]	2.50
P - Bolt Count	2
P - Bolt Size	3/8 x 1 3/4
P - C'Bore [in]	0.62
P - P1 [in]	1.00
P - Thru [in]	0.41
TAP	#10-32