

EZZE-MOUNT EZF-4009

Call 800-321-7800 or visit us online at www.nookindustries.com to configure and order your EZZE-MOUNT EZF-4009 today!

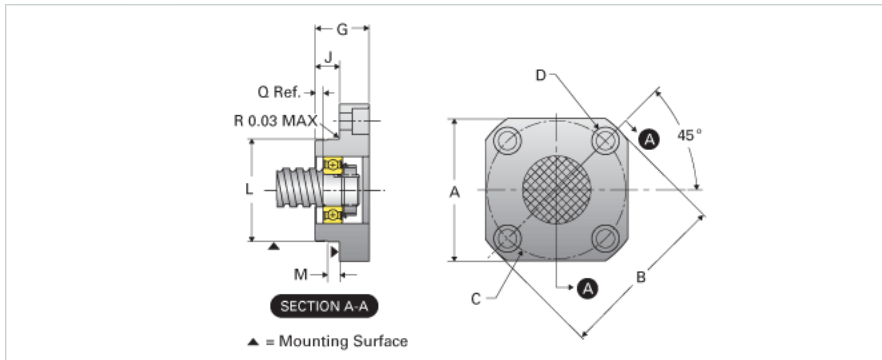
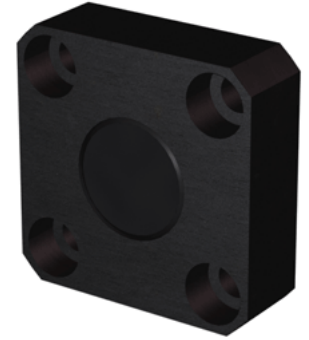

Product Info

| | |
|-----------------------------------|----------|
| Part Number | EZF-4009 |
| Machined End Code | 9 |
| Nominal Bearing Journal Size [mm] | 9 |

Dimensions

| | |
|--------------------|--------|
| A [in] | 2.00 |
| B - Diameter [in] | 2.60 |
| C Bolt Circle [in] | 2.000 |
| C'Bore [in] | 0.44 |
| D Thru [in] | 0.266 |
| G [in] | 1.00 |
| J [in] | 0.44 |
| L Maximum [in] | 1.4957 |
| L Minimum [in] | 1.4951 |
| M [in] | 0.188 |
| Q [in] | 0.13 |

Weight

| | |
|-------------|------|
| Weight [lb] | 0.70 |
|-------------|------|