

## EZZE-MOUNT EZF-3010

Call 800-321-7800 or visit us online at [www.nookindustries.com](http://www.nookindustries.com) to configure and order your EZZE-MOUNT EZF-3010 today!

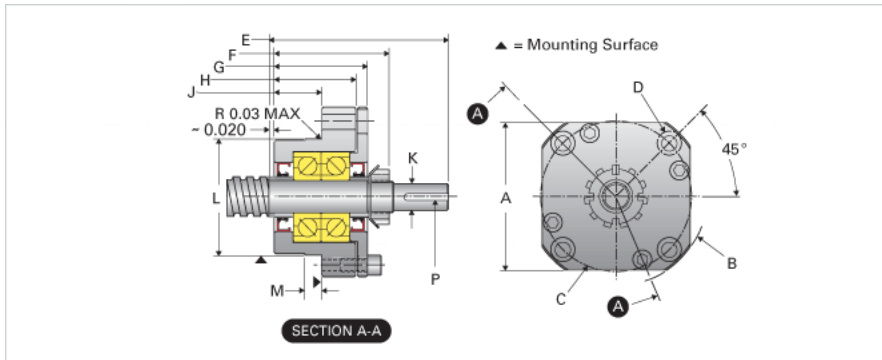
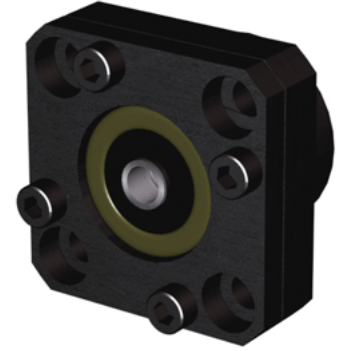

### Product Info

Part Number	EZF-3010
Machined End Code	10
Nominal Bearing Journal Size [mm]	10

### Dimensions

A [in]	2.00
B - Diameter [in]	2.60
C Bolt Circle [in]	2.00
C'Bore [in]	0.44
D Thru [in]	0.266
E [in]	2.50
F [in]	1.81
G [in]	1.33
H [in]	1.09
J [in]	0.71
K Shaft Diameter Maximum [in]	0.312
K Shaft Diameter Minimum [in]	0.311
L Minimum [in]	1.4951
L Maximum [in]	1.4957
M [in]	0.190
P [in]	0.125
Q [in]	0.13

### Weight

Weight [lb]	0.88
-------------	------