

EZZE-MOUNT EZF-1009

Call 800-321-7800 or visit us online at www.nookindustries.com to configure and order your EZZE-MOUNT EZF-1009 today!

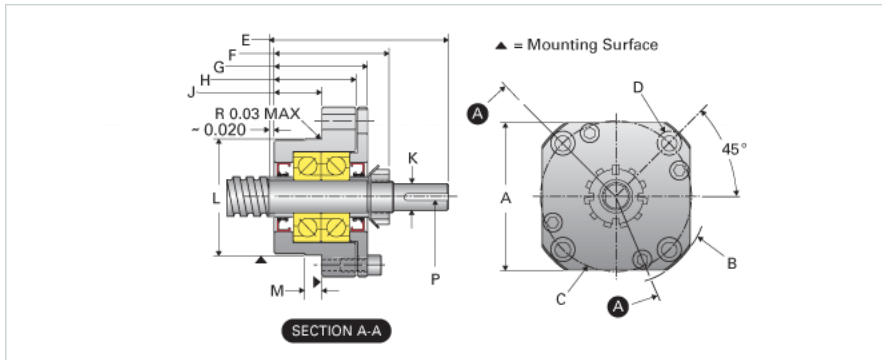

Product Info

Part Number	EZF-1009
Machined End Code	9
Nominal Bearing Journal Size [mm]	9

Dimensions

A [in]	2.00
B - Diameter [in]	2.60
C Bolt Circle [in]	2.00
C'Bore [in]	0.44
D Thru [in]	0.266
E [in]	2.38
F [in]	1.81
G [in]	1.33
H [in]	1.09
J [in]	0.71
K Shaft Diameter Maximum [in]	0.250
K Shaft Diameter Minimum [in]	0.249
L Minimum [in]	1.4951
L Maximum [in]	1.4957
M [in]	0.188
P [in]	0.094
Q [in]	0.13

Weight

Weight [lb]	0.88
-------------	------