

EZZE-MOUNT EZF-1007

Call 800-321-7800 or visit us online at www.nookindustries.com to configure and order your EZZE-MOUNT EZF-1007 today!

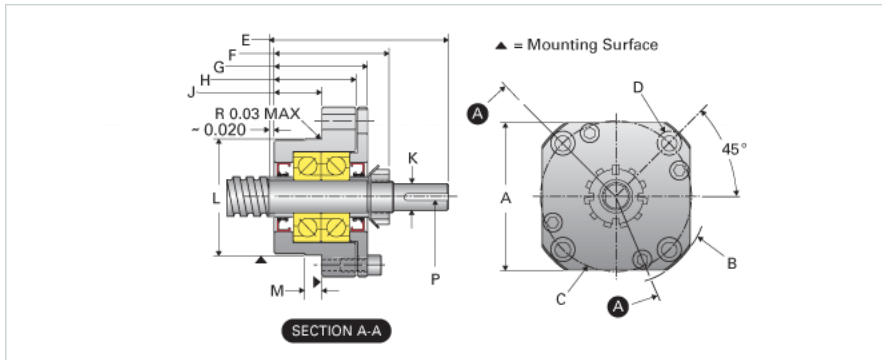

Product Info

Part Number	EZF-1007
Machined End Code	7
Nominal Bearing Journal Size [mm]	7

Dimensions

A [in]	1.88
B - Diameter [in]	2.44
C Bolt Circle [in]	1.88
C'Bore [in]	0.44
D Thru [in]	0.266
E [in]	1.94
F [in]	1.44
G [in]	1.06
H [in]	0.82
J [in]	0.50
K Shaft Diameter Maximum [in]	0.187
K Shaft Diameter Minimum [in]	0.186
L Minimum [in]	1.3770
L Maximum [in]	1.3775
M [in]	0.188
P [in]	0.063
Q [in]	0.13

Weight

Weight [lb]	0.62
-------------	------