

EZZE-MOUNT EZF-2030-34

Call 800-321-7800 or visit us online at www.nookindustries.com to configure and order your EZZE-MOUNT EZF-2030-34 today!

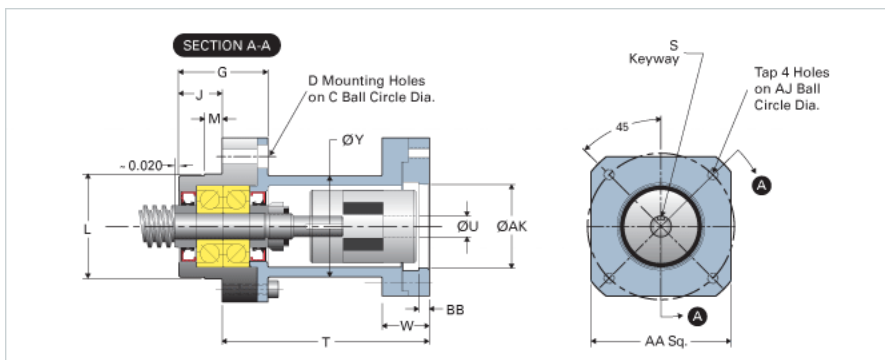
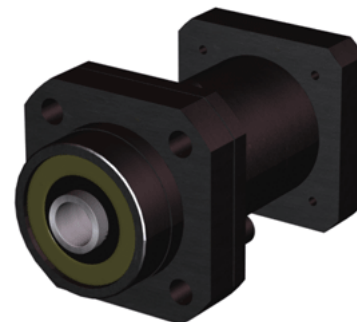

Product Info

Part Number	EZF-2030-34
Reference Code	Y3
Machined End Code	30
Nema Frame Reference	34
Nominal Bearing Journal Size [mm]	30

Dimensions

A [in]	4.38
AA [in]	4.00
AJ [in]	3.875
AK Maximum [in]	2.882
AK Minimum [in]	2.878
B - Diameter [in]	5.31
BB [in]	0.16
C Bolt Circle [in]	4.25
C Bore [in]	0.81
D Thru [in]	0.531
E [in]	4.86
F [in]	3.05
G [in]	2.36
H [in]	1.94
J [in]	1.19
K Shaft Diameter Maximum [in]	1.000
K Shaft Diameter Minimum [in]	0.999
L Maximum [in]	3.1482
L Minimum [in]	3.1492
M [in]	0.375
P [in]	0.250
Q [in]	0.25
S [in]	0.125
T [in]	5.78
U [in]	0.50
W [in]	1.67
Y [in]	3.00
TAP	#10-32