

## ActionJac 20SS-MSJ-U 24:1

Call 800-321-7800 or visit us online at [www.nookindustries.com](http://www.nookindustries.com) to configure and order your ActionJac 20SS-MSJ-U 24:1 today!

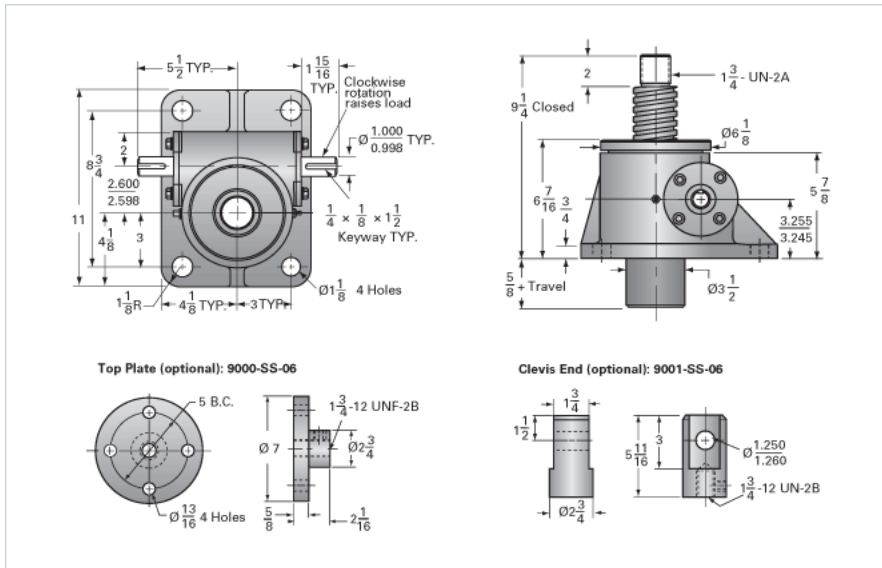
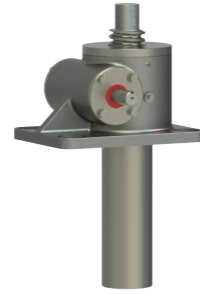

### Details

Capacity [Ton]	6.66
Gear Ratio	24:1
Turns of Worm per Inch Travel	48
Torque to Raise 1 lb. [in-lb]	0.0218
Lifting Screw Diameter [in]	2.50
Screw Lead [in]	0.500
Root Diameter [in]	1.908
Tare Drag Torque [in-lb]	40

### Performance Specifications

Maximum Allowable Input [hp]	1.50
Maximum Input Torque [in-lb]	291
Maximum Load at 1750 RPM	2478
Starting Torque	2 x Running Torque

### Weight

Base 0 Travel [lb]	85
Per Inch of Travel [lb]	2.00
Grease [lb]	2.3