

## ActionJac 35SS-MSJ-IR 32:1

Call 800-321-7800 or visit us online at [www.nookindustries.com](http://www.nookindustries.com) to configure and order your ActionJac 35SS-MSJ-IR 32:1 today!

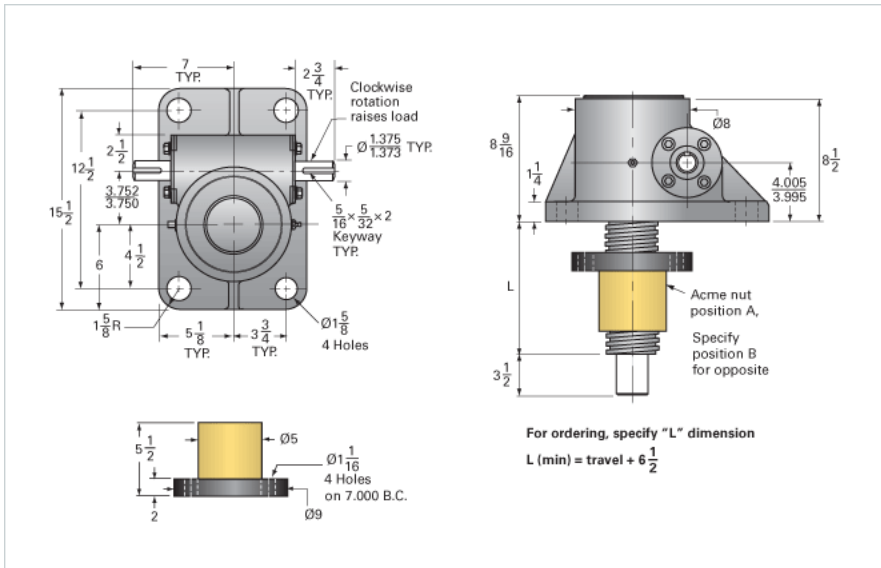
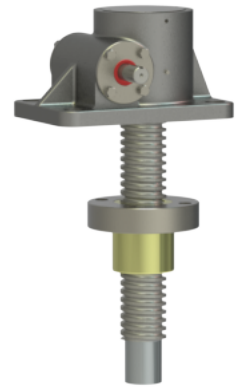

### Details

Capacity [Ton]	11.66
Gear Ratio	32:1
Turns of Worm per Inch Travel	48
Torque to Raise 1 lb. [in-lb]	0.0251
Lifting Screw Diameter [in]	3.75
Screw Lead [in]	0.667
Root Diameter [in]	3.083
Tare Drag Torque [in-lb]	50

### Performance Specifications

Maximum Allowable Input [hp]	3.50
Maximum Input Torque [in-lb]	600
Maximum Load at 1750 RPM	5022
Starting Torque	2 x Running Torque

### Weight

Base 0 Travel [lb]	165
Per Inch of Travel [lb]	3.50
Grease [lb]	3.5