

## ActionJac EM5-MSJ-UR 6:1

Call 800-321-7800 or visit us online at [www.nookindustries.com](http://www.nookindustries.com) to configure and order your ActionJac EM5-MSJ-UR 6:1 today!

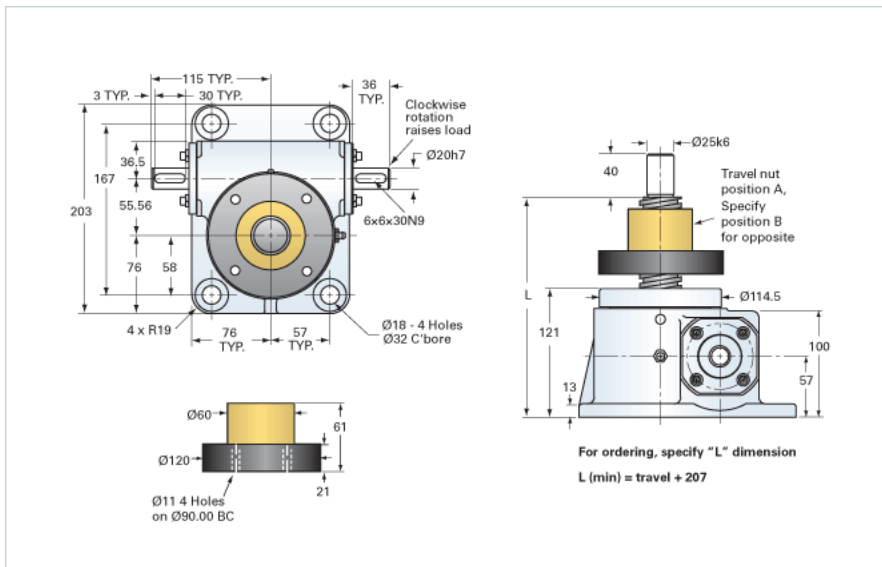

### Details

|                                 |      |
|---------------------------------|------|
| Capacity [kN]                   | 50   |
| Gear Ratio                      | 6:1  |
| Raise for One Turn of Worm [mm] | 1.17 |
| Torque to Raise 1 kN [Nm]       | 0.81 |
| No Load Torque [Nm]             | 1.13 |
| Lifting Screw Diameter [mm]     | 40   |
| Screw Lead [mm]                 | 7    |
| Root Diameter [mm]              | 30.9 |

### Performance Specifications

|  |                    |
|--|--------------------|
| Maximum Allowable Input [kW]           | 1.87               |
| Maximum Input Torque [Nm]              | 40.30              |
| Maximum Load at 1425 RPM [kN]          | 15.6               |
| Maximum Worm Speed at Rated Load [rpm] | 445                |
| Starting Torque                        | 2 x Running Torque |

### Weight

|                          |       |
|--------------------------|-------|
| Base 0 Travel [kg]       | 13.60 |
| Per 100mm of Travel [kg] | 0.81  |
| Grease [kg]              | 0.45  |