

ActionJac EM5-BSJ-UR 6:1

Call 800-321-7800 or visit us online at www.nookindustries.com to configure and order your ActionJac EM5-BSJ-UR 6:1 today!

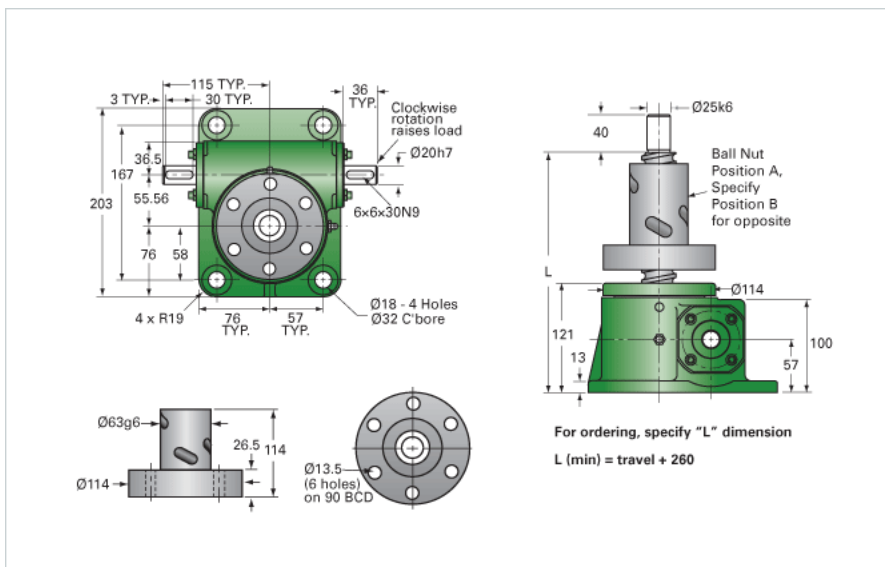

Details

Capacity [kN]	50
Gear Ratio	6:1
Raise for One Turn of Worm [mm]	1.67
Torque to Raise 1 kN [Nm]	0.39
No Load Torque [Nm]	1.13
Lifting Screw Diameter [mm]	40
Screw Lead [mm]	10
Root Diameter [mm]	34.8
BackDrive Holding Torque [Nm]	16.0

Performance Specifications

Maximum Allowable Input [kW]	2.28
Maximum Input Torque [Nm]	19.30
Maximum Load at 1425 RPM [kN]	39.4
Maximum Worm Speed at Rated Load [rpm]	1125
Starting Torque	1.5 x Running Torque

Weight

Base 0 Travel [kg]	15.90
Per 100mm of Travel [kg]	0.93
Grease [kg]	0.45