

## ActionJac EM20-BSJ-I 8:1

Call 800-321-7800 or visit us online at [www.nookindustries.com](http://www.nookindustries.com) to configure and order your ActionJac EM20-BSJ-I 8:1 today!

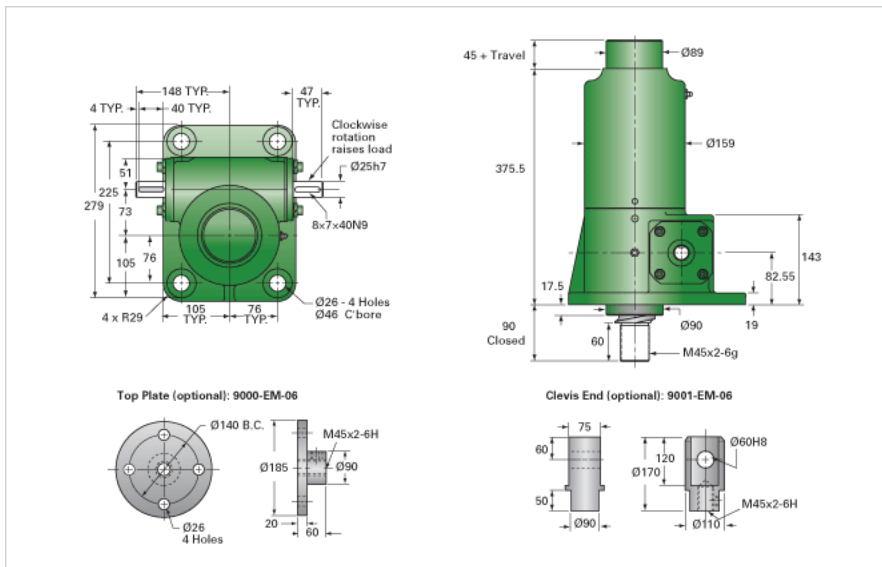

### Details

Capacity [kN]	200
Gear Ratio	8:1
Travel for 1 Turn of Worm [mm]	1.50
Torque to Raise 1 kN [Nm]	0.38
No Load Torque [Nm]	4.52
Lifting Screw Diameter [mm]	63
Screw Lead [mm]	12
Root Diameter [mm]	57.0
BackDrive Holding Torque [Nm]	61.0

### Performance Specifications

Maximum Allowable Input [kW]	5.60
Maximum Input Torque [Nm]	75.20
Maximum Load at 1425 RPM [kN]	99.8
Maximum Worm Speed at Rated Load [rpm]	710
Starting Torque	1.5 x Running Torque

### Weight

Base 0 Travel [kg]	38.60
Per 100mm of Travel [kg]	2.31
Grease [kg]	1.00