

ActionJac EM05-BSJ-I 5:1

Call 800-321-7800 or visit us online at www.nookindustries.com to configure and order your ActionJac EM05-BSJ-I 5:1 today!

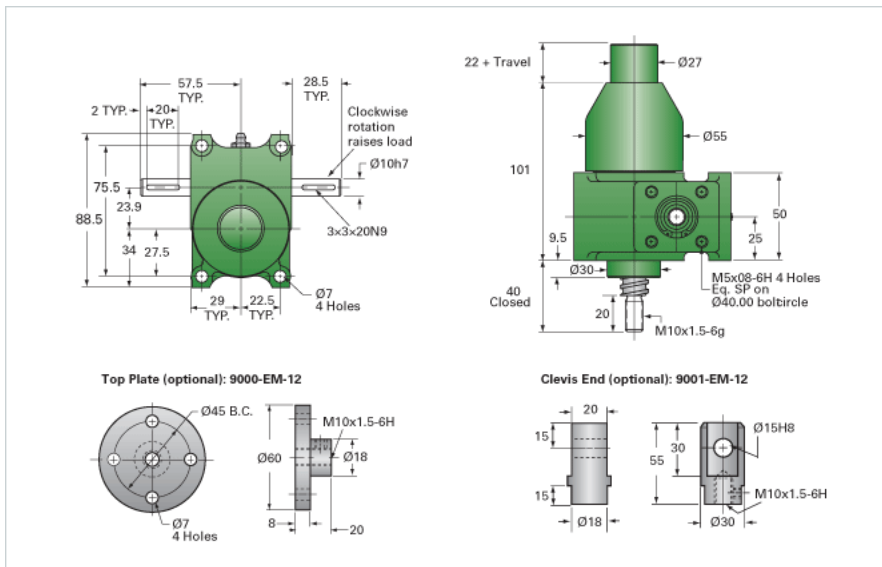

Details

| | |
|--------------------------------|------|
| Capacity [kN] | 5 |
| Gear Ratio | 5:1 |
| Travel for 1 Turn of Worm [mm] | 1.00 |
| Torque to Raise 1 kN [Nm] | 0.24 |
| No Load Torque [Nm] | 0.11 |
| Lifting Screw Diameter [mm] | 15.7 |
| Screw Lead [mm] | 5 |
| Root Diameter [mm] | 12.9 |
| BackDrive Holding Torque [Nm] | 1.0 |

Performance Specifications

| | |
|--|----------------------|
| Maximum Allowable Input [kW] | 0.12 |
| Maximum Input Torque [Nm] | 1.21 |
| Maximum Load at 1425 RPM [kN] | 5 |
| Maximum Worm Speed at Rated Load [rpm] | 1625 |
| Starting Torque | 1.5 x Running Torque |

Weight

| | |
|--------------------------|------|
| Base 0 Travel [kg] | 1.36 |
| Per 100mm of Travel [kg] | 0.14 |
| Grease [kg] | 0.14 |