

ActionJac MJ-50-I 5:1

Call 800-321-7800 or visit us online at www.nookindustries.com to configure and order your ActionJac MJ-50-I 5:1 today!

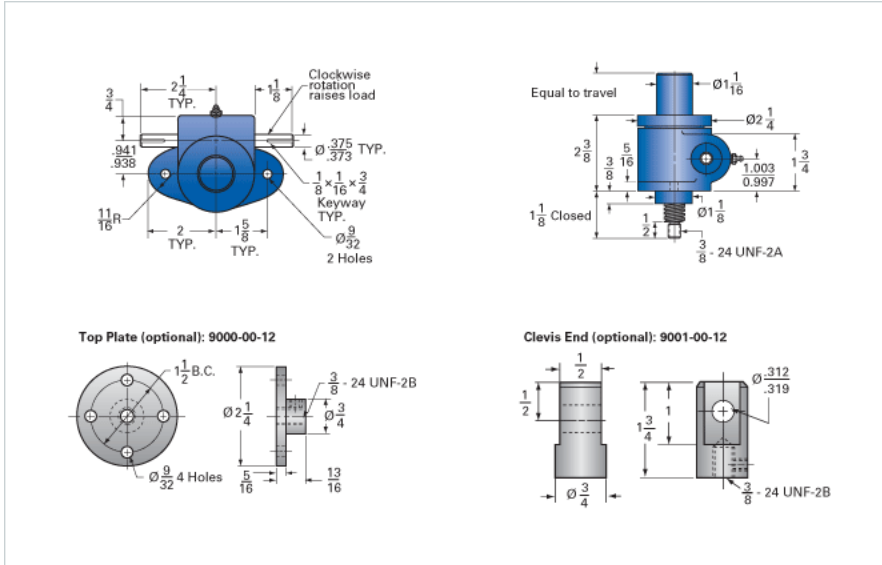

Details

Capacity [Ton]	0.5
Gear Ratio	5:1
Turns of Worm Per Inch Travel	50
Torque to Raise 1 lb. [in-lb]	0.0140
Lifting Screw Diameter [in]	0.50
Screw Lead [in]	0.100
Root Diameter [in]	0.359
Tare Drag Torque [in-lb]	1

Performance Specifications

Maximum Allowable Input [hp]	0.33
Maximum Input Torque [in-lb]	13.5
Compression Loading Maximum Travel at 1000 lbs. [lbs]	8.30
Compression Loading Maximum Travel at Any Load [lbs]	9.38
Maximum Worm Speed at Rated Load [rpm]	1560
Travel Rate at 1750 rpm [in/min]	36
Maximum Load at 1750 RPM [lb]	860
Starting Torque	2 x Running Torque

Weight

Base 0 Travel [lb]	2.5
Per Inch of Travel [lb]	0.20
Grease [lb]	0.5