

ActionJac 5-MSJ-UR 6:1

Call 800-321-7800 or visit us online at www.nookindustries.com to configure and order your ActionJac 5-MSJ-UR 6:1 today!

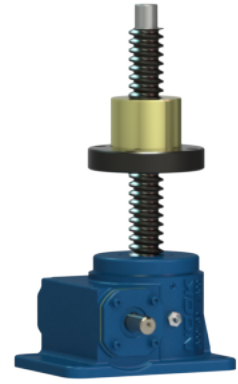
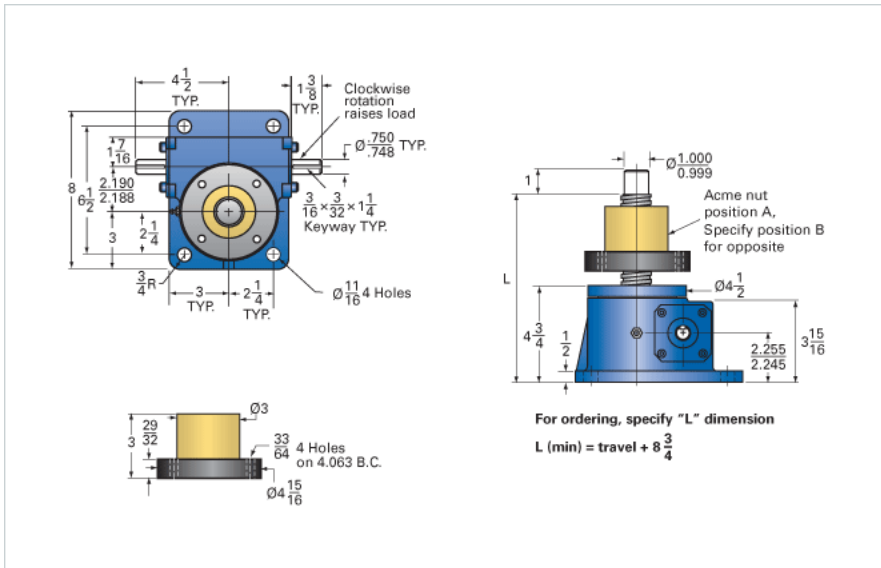

Details

Capacity [Ton]	5
Gear Ratio	6:1
Turns of Worm per Inch Travel	16
Torque to Raise 1 lb. [in-lb]	0.0376
Lifting Screw Diameter [in]	1.50
Screw Lead [in]	0.375
Root Diameter [in]	1.066
Tare Drag Torque [in-lb]	10

Performance Specifications

Maximum Allowable Input [hp]	3.00
Maximum Input Torque [in-lb]	376
Maximum Worm Speed at Rated Load [rpm]	500
Maximum Load at 1750 RPM [lb]	2873