

## ActionJac 5-MSJ-I 6:1

Call 800-321-7800 or visit us online at [www.nookindustries.com](http://www.nookindustries.com) to configure and order your ActionJac 5-MSJ-I 6:1 today!

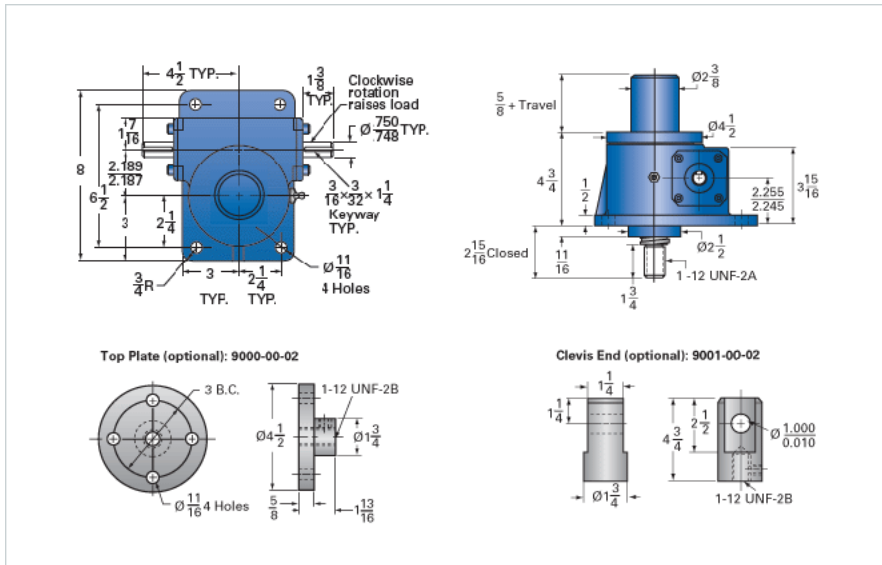

### Details

Capacity [Ton]	5
Gear Ratio	6:1
Turns of Worm per Inch Travel	16
Torque to Raise 1 lb. [in-lb]	0.0376
Lifting Screw Diameter [in]	1.50
Screw Lead [in]	0.375
Root Diameter [in]	1.066
Tare Drag Torque [in-lb]	10

### Performance Specifications

Maximum Allowable Input [hp]	3.00
Maximum Input Torque [in-lb]	376
Maximum Worm Speed at Rated Load [rpm]	500
Maximum Load at 1750 RPM [lb]	2873
Starting Torque	2 x Running Torque

### Weight

Base 0 Travel [lb]	30
Per Inch of Travel [lb]	0.70
Grease [lb]	1.0