

ActionJac 2.5-MSJ-DC 24:1

Call 800-321-7800 or visit us online at www.nookindustries.com to configure and order your ActionJac 2.5-MSJ-DC 24:1 today!

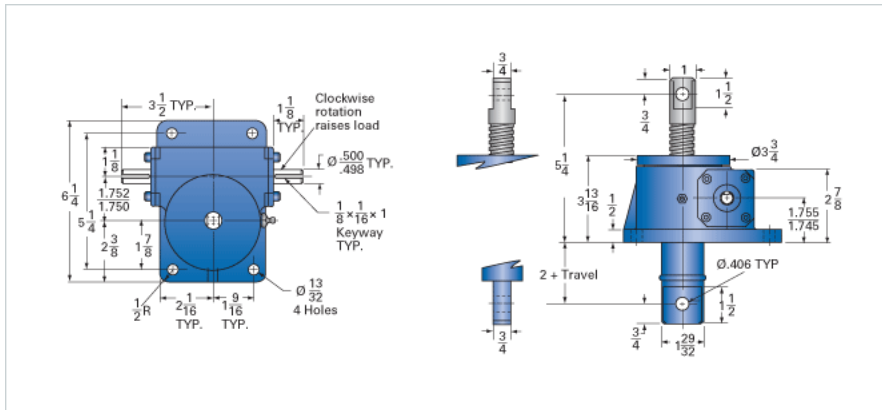

Details

Capacity [Ton]	2.5
Gear Ratio	24:1
Turns of Worm per Inch Travel	96
Torque to Raise 1 lb. [in-lb]	0.0106
Torque to Raise 1 lb. Keyed [in-lb]	0.0122
Lifting Screw Diameter [in]	1.00
Screw Lead [in]	0.250
Root Diameter [in]	0.698
Tare Drag Torque [in-lb]	5

Performance Specifications

Maximum Allowable Input [hp]	0.50
Maximum Input Torque [in-lb]	53
Maximum Worm Speed at Rated Load Non-keyed [rpm]	594
Maximum Worm Speed at Rated Load Keyed [rpm]	516
Maximum Load at 1750 RPM Non-keyed [lb]	1699
Maximum Load at 1750 RPM Keyed [lb]	1476
Starting Torque	2 x Running Torque

Weight

Base 0 Travel [lb]	17
Per Inch of Travel [lb]	0.45
Grease [lb]	0.5