

ActionJac 10HL-BSJ-I 24:1

Call 800-321-7800 or visit us online at www.nookindustries.com to configure and order your ActionJac 10HL-BSJ-I 24:1 today!

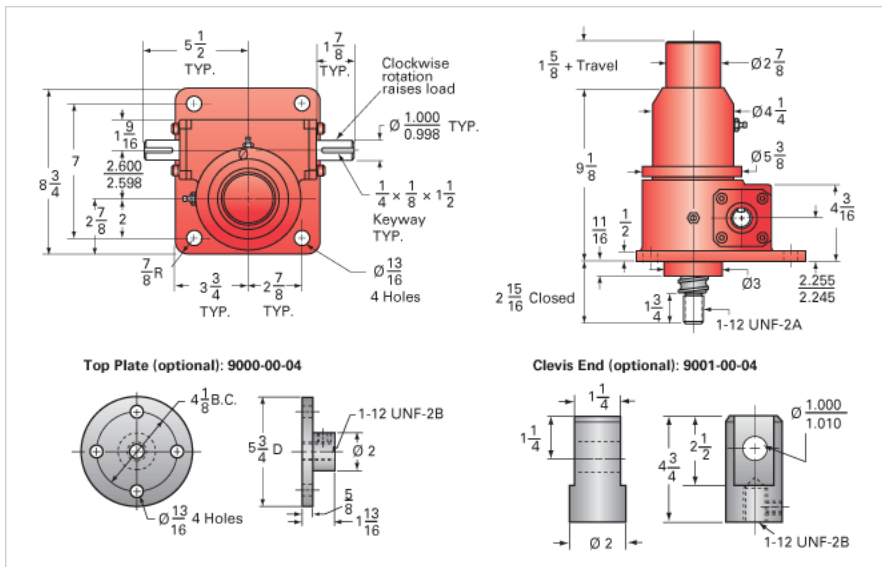

Details

Capacity [Ton]	10
Gear Ratio	24:1
Turns of Worm per Inch Travel	24
Torque to Raise 1 lb. [in-lb]	0.0162
Lifting Screw Diameter [in]	1.50
Screw Lead [in]	1.000
Root Diameter [in]	1.140
BackDrive Holding Torque [ft-lb]	6.0
Tare Drag Torque [in-lb]	20

Performance Specifications

Maximum Allowable Input [hp]	1.50
Maximum Input Torque [in-lb]	323
Maximum Worm Speed at Rated Load [rpm]	293
Maximum Load at 1750 RPM [lb]	3334
Starting Torque	1.5 x Running Torque

Weight

Base 0 Travel [lb]	50
Per Inch of Travel [lb]	0.80
Grease [lb]	1.5