

ActionJac 3-BSJ-IR 6:1

Call 800-321-7800 or visit us online at www.nookindustries.com to configure and order your ActionJac 3-BSJ-IR 6:1 today!

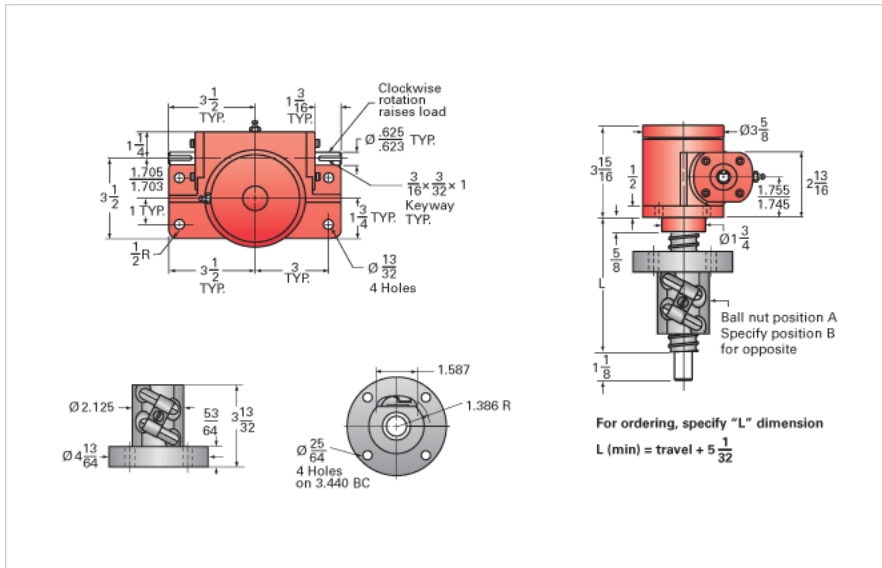

Details

| | |
|----------------------------------|--------|
| Capacity [Ton] | 3 |
| Gear Ratio | 6:1 |
| Turns of Worm per Inch Travel | 14.53 |
| Torque to Raise 1 lb. [in-lb] | 0.0167 |
| Lifting Screw Diameter [in] | 1.17 |
| Screw Lead [in] | 0.413 |
| Root Diameter [in] | 0.870 |
| BackDrive Holding Torque [ft-lb] | 6.0 |
| Tare Drag Torque [in-lb] | 6 |

Performance Specifications

| | |
|--|----------------------|
| Maximum Allowable Input [hp] | 2.00 |
| Maximum Input Torque [in-lb] | 100 |
| Maximum Worm Speed at Rated Load [rpm] | 1260 |
| Maximum Load at 1750 RPM [lb] | 4313 |
| Starting Torque | 1.5 x Running Torque |

Weight

| | |
|-------------------------|------|
| Base 0 Travel [lb] | 18.5 |
| Per Inch of Travel [lb] | 0.60 |
| Grease [lb] | 0.5 |