

ActionJac 2.5HL-BSJ-IK 24:1

Call 800-321-7800 or visit us online at www.nookindustries.com to configure and order your ActionJac 2.5HL-BSJ-IK 24:1 today!

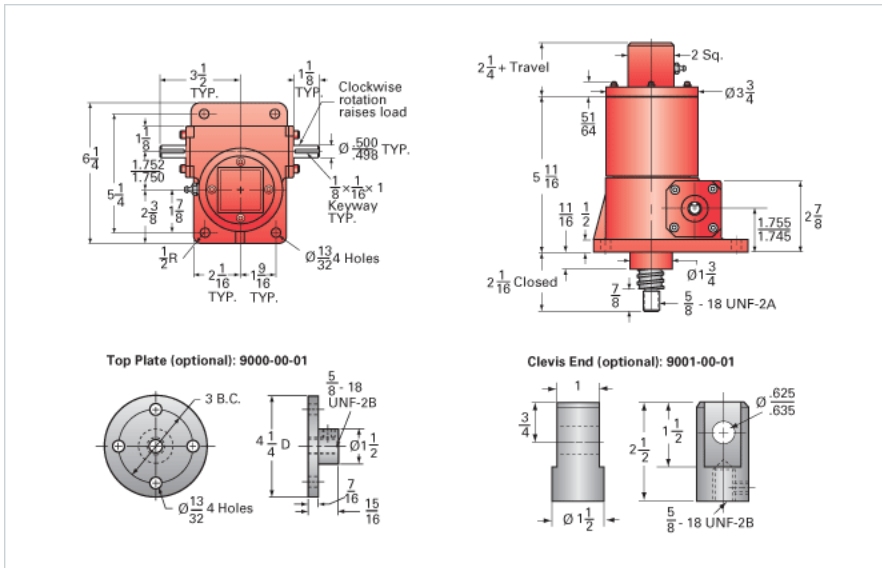

Details

Capacity [Ton]	2.5
Gear Ratio	24:1
Turns of Worm per Inch Travel	24
Torque to Raise 1 lb. [in-lb]	0.0187
Lifting Screw Diameter [in]	1.00
Screw Lead [in]	1.000
Root Diameter [in]	0.820
BackDrive Holding Torque [ft-lb]	5.0
Tare Drag Torque [in-lb]	5

Performance Specifications

Maximum Allowable Input [hp]	0.50
Maximum Input Torque [in-lb]	85
Maximum Worm Speed at Rated Load [rpm]	337
Maximum Load at 1750 RPM [lb]	964
Starting Torque	1.5 x Running Torque

Weight

Base 0 Travel [lb]	17
Per Inch of Travel [lb]	0.60
Grease [lb]	0.5