

NH55TA

Call 800-321-7800 or visit us online at www.nookindustries.com to configure and order your NH55TA today!

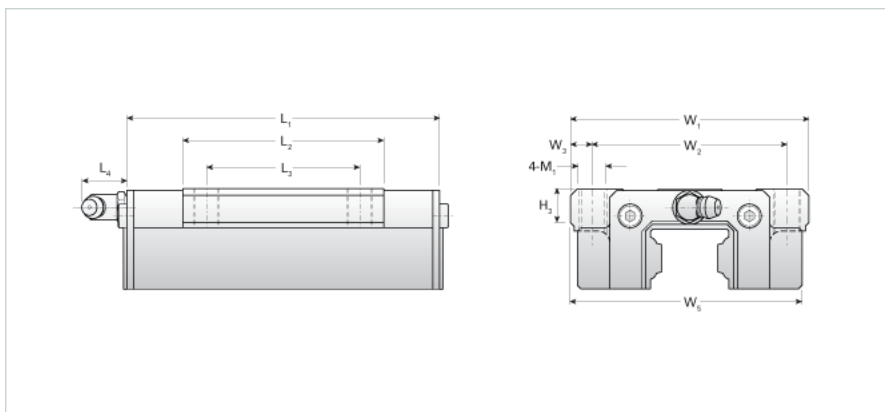
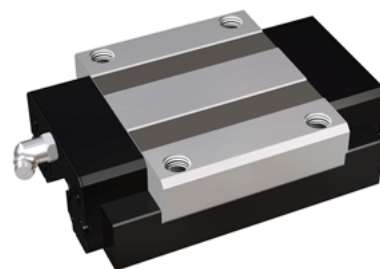

Details	
Size [mm]	55
Dimensions	
L1 [mm]	189
L2 [mm]	124
L3 [mm]	95
L4 [mm]	16
M1 x l	M14X23
H3 [mm]	17
W1 [mm]	140
W2 [mm]	116
W3 [mm]	12
W5 [mm]	130
Forces and Torques	
Basic Load Ratings C [kN]	90.02
Basic Load Ratings C [lbf]	20232
Basic Load Ratings C0 [kN]	137.09
Basic Load Ratings C0 [lbf]	30811
Static Moment Ratings-Ma [kN-m]	2.22
Static Moment Ratings-Ma [lb-in]	19617
Static Moment Ratings-Mb [kN-m]	2.22
Static Moment Ratings-Mb [lb-in]	19617
Static Moment Ratings-Mc [kN-m]	4.25
Static Moment Ratings-Mc [lb-in]	37671
Weight	
Weight-Block [kg]	4.4
Grease Fitting	
Grease Fitting Part Number	B-PT 1/8