

QSR 80

Call 800-321-7800 or visit us online at www.nookindustries.com to configure and order your QSR 80 today!

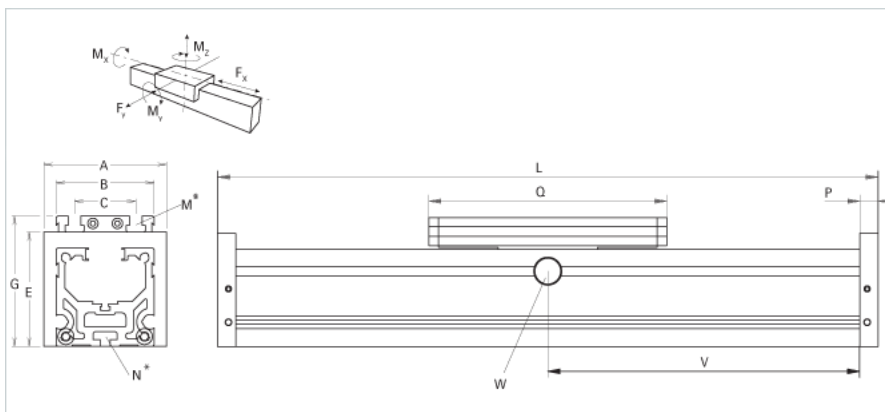

Details	
Size	80
Dimensions	
Basic Length L [mm]	270
A [mm]	100
B [mm]	80
C [mm]	50
E [mm]	93
G [mm]	106
M	M8
N	M6
P [mm]	17
Q [mm]	232
Speed	
Speed Maximum [m/s]	5
Forces and Torques	
F _x [N] 10000 km	-
F _y [N] 10000 km	2550
F _z [N] 10000 km	6050
M _x [Nm] 10000 km	75
M _y [Nm] 10000 km	222
M _z [Nm] 10000 km	210
F _x [N] 5000 km	-
F _y [N] 5000 km	3570
F _z [N] 5000 km	8500
M _x [Nm] 5000 km	107
M _y [Nm] 5000 km	310
M _z [Nm] 5000 km	296
Geometrical moments of inertia of aluminum profile	
Elastic modulus [N/mm ²]	70000
I _x [mm ⁴]	1650000
I _y [mm ⁴]	1870000
Weight	
Additional Weight per 100 mm [kg]	0.96
Basic Weight [kg]	4.9