

## DSR 160

Call 800-321-7800 or visit us online at [www.nookindustries.com](http://www.nookindustries.com) to configure and order your DSR 160 today!

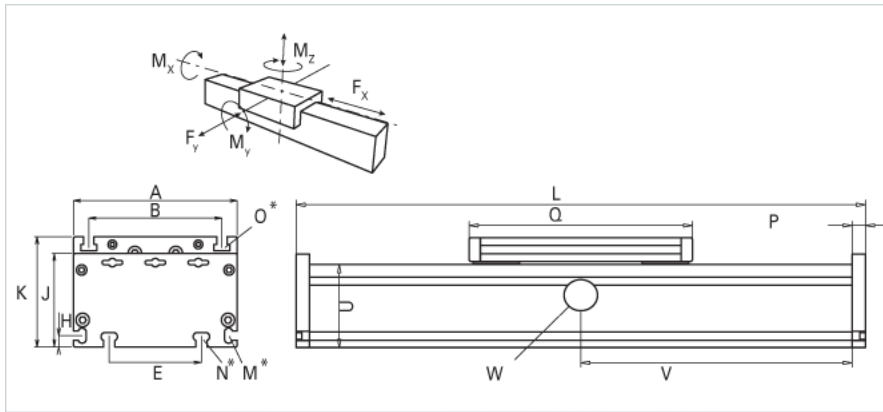

### Details

Size 160

### Dimensions

Basic Length L [mm]	240
A [mm]	160
B [mm]	130
E [mm]	90
H [mm]	11
J [mm]	90
K [mm]	106
M	M6
N	M8
O	M8
P [mm]	12
Q [mm]	200
U [mm]	80

### Speed

Speed Maximum [m/s] 5

### Forces and Torques

Fy [N] 10000 km	1775
Fz [N] 10000 km	4189
Mx [Nm] 10000 km	224
My [Nm] 10000 km	225
Mz [Nm] 10000 km	238
Fy [N] 5000 km	2236
Fz [N] 5000 km	5278
Mx [Nm] 5000 km	282
My [Nm] 5000 km	283
Mz [Nm] 5000 km	300

### Geometrical moments of inertia of aluminum profile

Elastic modulus [N/mm <sup>2</sup> ]	70000
Ix [mm <sup>4</sup> ]	2130000
Iy [mm <sup>4</sup> ]	1230000

### Weight

Additional Weight per 100 mm [kg]	1.50
Basic Weight [kg]	7.0