

ELZG 40

Call 800-321-7800 or visit us online at www.nookindustries.com to configure and order your ELZG 40 today!

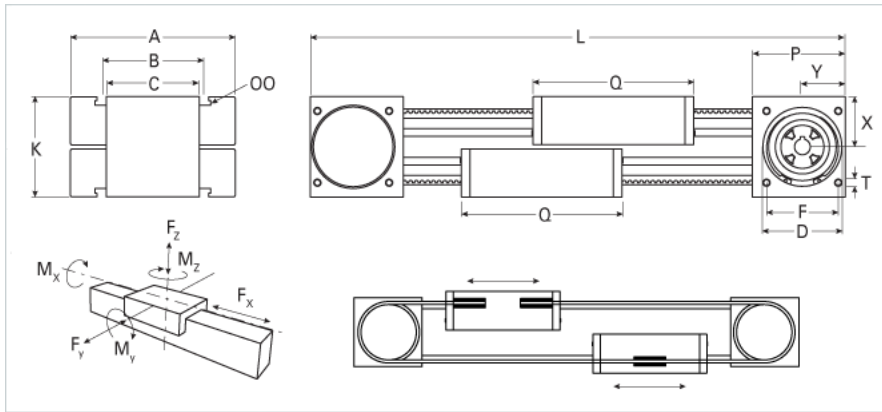
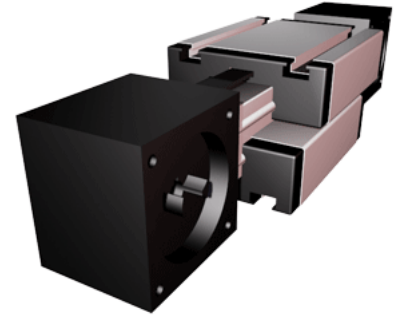

Details

Size	40
Belt	5M12
mm/Rev	160
Number of Teeth	320

Dimensions

Basic Length L [mm]	265
A [mm]	100
B [mm]	66
C [mm]	60
D [mm]	55
F [mm]	55
G [mm]	-
H [mm]	-
K [mm]	70
MM	-
OO	M6
P [mm]	70
Q [mm]	122
T	M6
X [mm]	35
Y [mm]	33
Shaft Diameter and Length [mm]	14 x 35
Key	5x5x28

Speed

Speed Maximum [m/s]	4
---------------------	---

Forces and Torques

No-load torque [Nm]	0.3
Tensile force 0.2 sec [N]	480
Tensile force permanent [N]	390
Fx dynamic [N]	350
Fy dynamic [N]	700
Fz dynamic [N]	650
Mx dynamic [Nm]	20
My dynamic [Nm]	18
Mz dynamic [Nm]	25
Fx static [N]	390
Fy static [N]	1200
Fz static [N]	900
Mx static [Nm]	25
My static [Nm]	32
Mz static [Nm]	35

Geometrical moments of inertia of aluminum profile

Elastic modulus [N/mm ²]	70000
Ix [mm ⁴]	132000
Iy [mm ⁴]	134000

Weight

Additional Weight per 100 mm [kg]	0.29
Basic Weight [kg]	4.0

Values for Calculating Inertias

Pulley Material	Steel
Pulley Diameter [mm]	50.93
Effective Pulley Width [mm]	60
Belt Weight [kg/m]	0.074

Standard Carriage Weight [kg]

0.52

No-load torque [Nm]

0.3

Friction Coefficient

0.01
