

PowerTrax 121-08-SXX

Call 800-321-7800 or visit us online at www.nookindustries.com to configure and order your PowerTrax 121-08-SXX today!

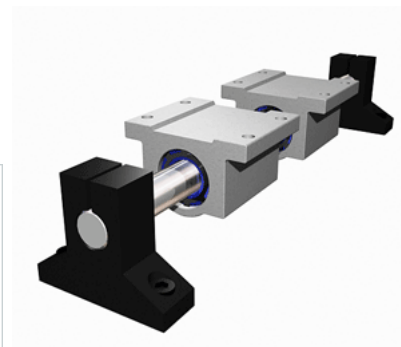
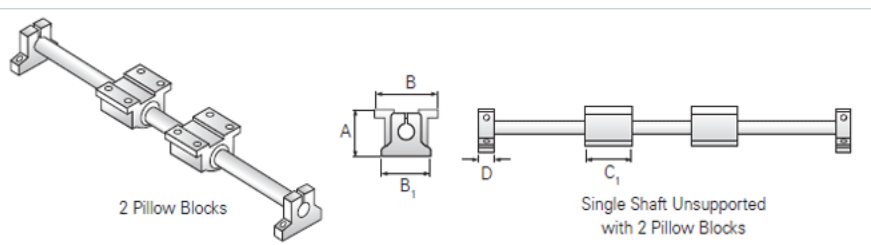

Product Info

Nominal Shaft Diameter [in]	0.50
Pillow Block	XEP-8
End Support	NSB-8

Dimensions

A +/-0.003 [in]	1.687
B [in]	2.00
B1 [in]	2.00
C1 [in]	1.69
D [in]	0.63

Performance Specifications

Load Maximum/Block [lbf]	175
--------------------------	-----