

## PowerTrax NSR-20-PD

Call 800-321-7800 or visit us online at [www.nookindustries.com](http://www.nookindustries.com) to configure and order your PowerTrax NSR-20-PD today!

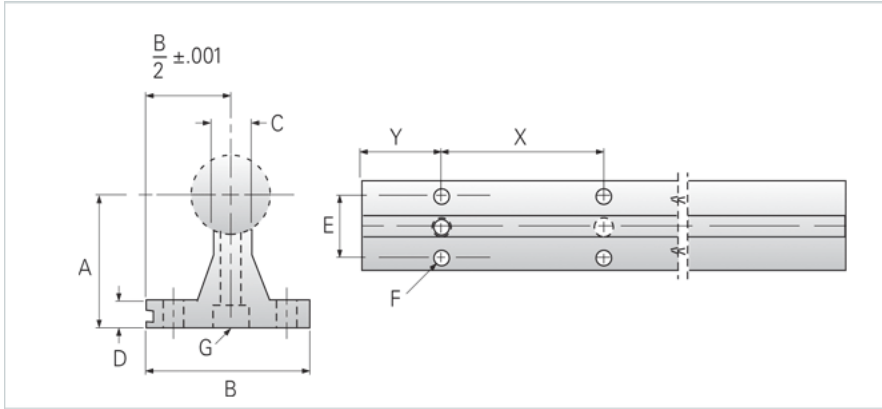
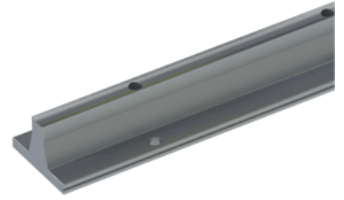

### Product Info

Nominal Shaft Diameter [in] 1.25

### Dimensions

A +/-0.002 [in]	2.125
B [in]	2.50
C [in]	0.563
D [in]	0.313
E [in]	1.88
X	6
Y	3
F Bolt	5/16"
F Hole [in]	0.343
G Hole [in]	0.343
G Screw	5/16-18x1-3/4

### Part Number

24" Part Number	NSR-20-PD-24
36" Part Number	NSR-20-PD-36
48" Part Number	NSR-20-PD-48

### Weight

Weight Per Foot [lb] 2.00