

## PowerTrax NSR-16-PD

Call 800-321-7800 or visit us online at [www.nookindustries.com](http://www.nookindustries.com) to configure and order your PowerTrax NSR-16-PD today!

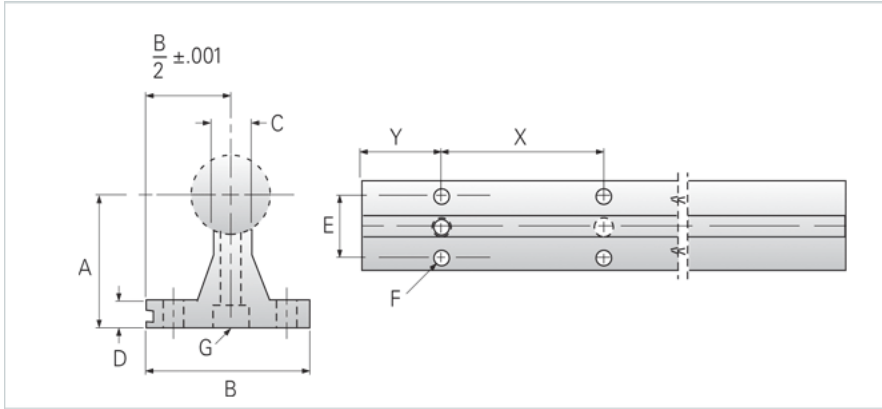
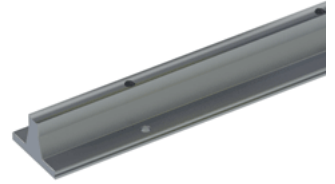

### Product Info

Nominal Shaft Diameter [in] 1.00

### Dimensions

A +/-0.002 [in]	1.750
B [in]	2.13
C [in]	0.500
D [in]	0.250
E [in]	1.50
X	6
Y	3
F Bolt	1/4"
F Hole [in]	0.281
G Hole [in]	0.281
G Screw	1/4-20x1-1/2

### Part Number

24" Part Number	NSR-16-PD-24
36" Part Number	NSR-16-PD-36
48" Part Number	NSR-16-PD-48

### Weight

Weight Per Foot [lb] 1.20