

NLR-12-PD

Call 800-321-7800 or visit us online at www.nookindustries.com to configure and order your NLR-12-PD today!

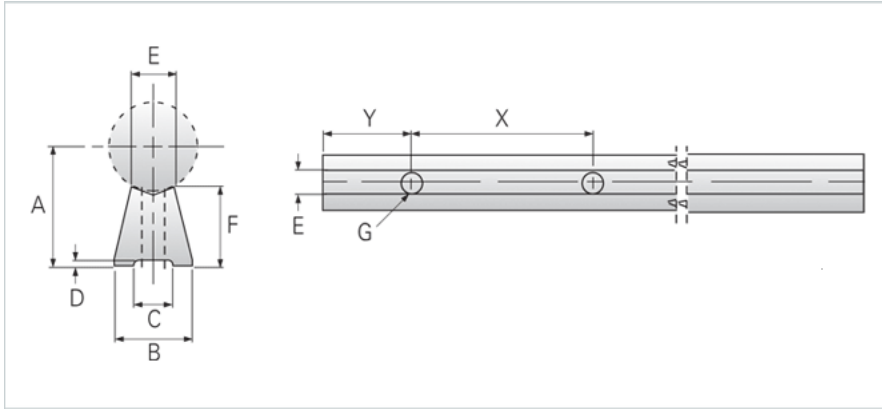

Product Info

Nominal Shaft Diameter [in] 0.75

Dimensions

A +/-0.002 [in]	0.750
B [in]	0.51
C [in]	0.221
D [in]	0.06
E [in]	0.335
F [in]	0.412
G - Hole [in]	0.221
X	6
Y	3
G - Bolt	10

Part Number

12" Part Number	NLR-12-PD-12
24" Part Number	NLR-12-PD-24
36" Part Number	NLR-12-PD-36
48" Part Number	NLR-12-PD-48

Weight

Weight Per Foot [lb] 0.21