

RAD-3066-HD/05XX

Call 800-321-7800 or visit us online at www.nookindustries.com to configure and order your RAD-3066-HD/05XX today!

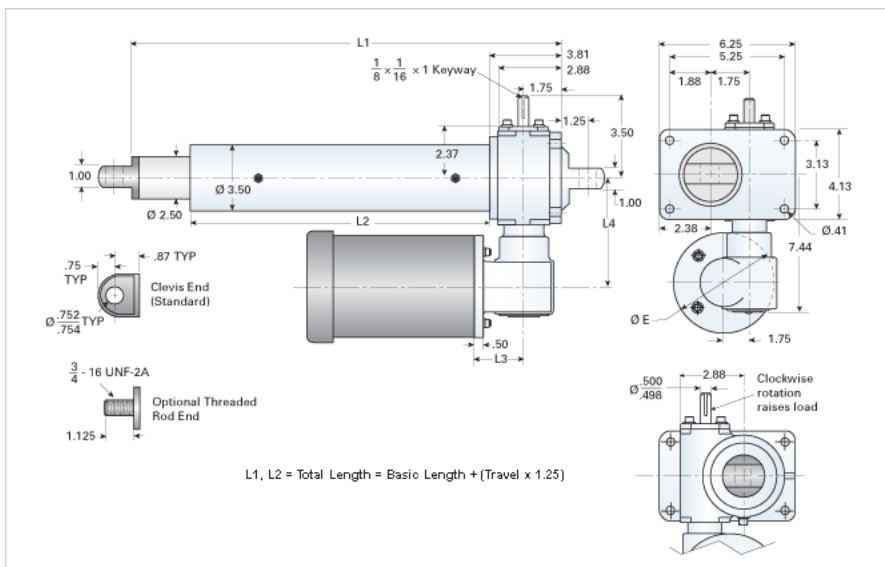

Performance Specifications

Travel Rate [in/min]	20
Dynamic Capacity [lb]	4775
Rated Life [in]	540000
Motor Horse Power	0.5
Maximum Rod Reaction Torque [in-lb]	349
Std. Brake Torque [ft-lb]	3
Approximate Stopping Distance No Load [in]	0.02
Approximate Stopping Distance Full Load [in]	0.02

Details

Gear Ratio Primary Reduction	6:1
Gear Ratio Secondary Reduction	6:1
Input Turns Per Inch Of Travel	87.18
Torque To Raise 1 lb. [in-lb]	0.0041
Max Capacity [lb]	6000
Max HP [hp]	0.5

Weight

Basic Weight [lb]	51
Per Inch of Travel [lb]	1.31

Tube Dimensions

L1 Basic Length [in]	12.44
L2 Basic Length [in]	7.31

NEMA 56C Dimensions

L3 [in]	3.69
L4 [in]	5.63
E [in]	6.69

NEMA 180TC Dimensions

L3 [in]	-
L4 [in]	-
F [in]	-